

# Cooling Techniques for Photovoltaic Systems: A Comprehensive Review of Phase Change Materials

Sandeep Yadav  
Department of Mechanical Engineering, MBM University

Surendra Kumar Singh  
Department of Mechanical Engineering, MBM University

Abhilasha Chaudhary  
Department of Mechanical Engineering, MBM University

<https://hdl.handle.net/2324/7420062>

---

出版情報 : Evergreen. 13 (2), pp.432-454, 2026-06. 九州大学グリーンテクノロジー研究教育センター  
バージョン :  
権利関係 : Creative Commons Attribution 4.0 International



# Cooling Techniques for Photovoltaic Systems: A Comprehensive Review of Phase Change Materials

Sandeep Yadav<sup>1,\*</sup>, Surendra Kumar Singh<sup>1</sup>, Abhilasha Chaudhary<sup>1</sup>

<sup>1</sup>Department of Mechanical Engineering, MBM University, Jodhpur, Rajasthan, 342011, India

\*Author to whom correspondence should be addressed:

E-mail: ydv.sndp3004@gmail.com

(Received February 17, 2025; Revised September 03, 2025; Accepted March 12, 2026)

**Abstract:** Photovoltaic (PV) systems are a promising renewable energy technology, but their performance is negatively impacted by high operating temperatures. This comprehensive review examines various cooling techniques for PV systems, emphasizing the role of phase change materials (PCMs) and comparing their effectiveness with other cooling methods. Passive and active cooling techniques, including water and air-based techniques, PCM integration, thermoelectric cooling, and radiative cooling, were systematically analyzed. The originality lies in its systematic classification of cooling techniques based on heat transfer mechanisms and a detailed evaluation of their performance, economic feasibility, and environmental impact. Quantitative findings indicate that active cooling methods achieve the highest temperature reductions (up to 30 °C) and power gains (15–23 %), but require additional energy and increase complexity of system. Among passive methods, optimized PV/PCM systems provide temperature drops of 10–33 °C and electrical power increases of 10–30 % without any energy input, outperforming conventional passive methods and approaching active cooling performance. Hybrid PV/T/PCM configurations further improve overall energy output by utilizing recovered heat, shortening payback periods from 8–10 years (standalone PV/PCM) to 3–6 years. Additionally, innovative radiative cooling materials and thermoelectric cooling techniques showed temperature reductions of up to 10°C and 15.2% enhancement in electrical efficiency, respectively. Despite their benefits, PCMs face challenges such as high costs, low thermal conductivity, and reliability issues. Life cycle analyses indicate that reducing PCM costs and incorporating advanced designs, such as finned containers or hybrid PV/T systems, enhances heat transfer and economic feasibility while significantly shortening payback periods. This review provides a comparative analysis of cooling techniques, quantifies performance parameters and identifies key research directions to optimize thermal management in PV systems for sustainable energy generation.

**Keywords:** Cooling techniques; Electrical efficiency; Life cycle analyses; Phase change materials; Photovoltaic; Thermal management

## 1. Introduction

Growing demand of energy for industrial and household applications has prompted interest in renewable energy as a replacement for fossil fuels<sup>1</sup>). Traditional usage of fossil fuels has created severe environmental issues due to greenhouse gas emissions that cause global warming and climate change<sup>2</sup>). Various technologies have been used to address energy issues and reduce dependence on fossil fuels. As a result, renewable energy sources have emerged as a critical alternative to meet huge increase in energy demand. They are capable of satisfying the extra energy demand while also being eco-friendly<sup>3,4</sup>). One of the renewable energy sources is solar energy<sup>5,6</sup>). Recent

decades have seen an extensive amount of research into solar energy conversion technologies, leading to notable advancements in photovoltaic (PV), solar thermal, photochemical, and thermal photovoltaic systems<sup>7-9</sup>). The photovoltaic system generates electricity directly from sunlight, by using solar cells<sup>10-12</sup>). The heat source of a photovoltaic system is solar radiation. Photovoltaic modules absorb 80% of incident solar radiation and converts 15-20% of this absorbed energy into electrical energy, depending on the efficiency of PV panel. The remaining absorbed energy is generating heat in the photovoltaic panel<sup>13,14</sup>). Heat generated in PV panels raises their operating temperature, which negatively impacts their electrical performance, reduces lifespan, and

lengthens payback periods<sup>15</sup>). To counter this, various solutions are implemented to keep PV module temperatures as low as possible. Many cooling technologies from thermal engineering are adapted for this purpose, focusing on enhancing heat transfer through conduction and convection. These technologies fall into two main categories: passive cooling and active cooling. Passive cooling relies on natural processes, using air, liquids (like water or nanofluids), phase change materials (PCMs), or sky radiation as cooling mediums<sup>16,17</sup>.

In contrast, active cooling requires additional energy input to circulate coolants, typically air or water<sup>18,19</sup>. Most active cooling approaches are water-based and often used in PV/T (Photovoltaic/Thermal) systems, which capture both electrical energy and waste heat from PV panels<sup>20,21</sup>. PV/T technology uses different working fluids such as air, water, thermic fluids, and nanofluids to extract heat. This dual-purpose technology not only improves electrical output but can also be used for space or water heating, making it ideal for distributed PV systems on building rooftops or facades to boost solar energy capture<sup>22</sup>. However, practical challenges remain, including improving heat transfer rates and efficiently dissipating and utilizing the excess heat. Consequently, PV/T systems often become complex or require extra electricity for operation, which can impact cost-effectiveness<sup>23,24</sup>.

Recently, researchers have been exploring PCMs, which can absorb substantial latent heat during phase changes with minimal temperature increase. Attaching PCM to back of PV panels in PV/PCM modules can keep PV panels at lower temperatures, improving conversion efficiency<sup>25-27</sup>. PV/PCM systems do not require fluid flow or additional electricity, making them low-maintenance compared to traditional PV/T systems<sup>28</sup>. PCMs are considered effective for capturing thermal energy from renewable sources, with numerous studies validating their application in solar and building energy conservation, establishing a basis for cogeneration in PV/PCM systems. Despite growing research interest and numerous publications on PV/PCM technology, practical application remains uncertain. Challenges such as low thermal conductivity of PCMs, limited heat storage capacity, potential leakage, and high costs still impact reliability and cost-effectiveness of PV/PCM systems compared to alternative solutions. Thus, a systematic review of PV/PCM research is essential to consolidate achievements, identify challenges, and highlight promising research directions to advance practical applications.

This paper offers a comprehensive review of photovoltaic cooling technologies, with a special emphasis on phase change materials. It explores current research, significant achievements, limitations, and practical challenges, along with an economic and environmental assessment of PV/PCM systems. In addition to PCM-based cooling, the paper reviews various conventional and advanced cooling

techniques, facilitating a comparative analysis of performance parameters. Most existing reviews of PV/PCM systems emphasize PCMs alone, often neglecting alternative cooling methods. To address this gap, the paper provides a balanced evaluation of PCM-based cooling and other techniques. The review starts by introducing PV technology and quantify the detrimental impact of elevated operating temperature on PV electrical performance and establish need for effective thermal management. It then classifies various cooling methods based on heat transfer mechanisms and critically evaluate all major PV cooling methods using consistent quantitative performance metrics such as temperature reduction, electrical efficiency gain, and power output increase. Subsequent sections analyse the PV/PCM systems by highlighting performance improvement, persistent limitations (low thermal conductivity, partial melting, cycling degradation, leakage, and high cost), and effective enhancement strategies. Finally, perform a detailed economic and life-cycle analysis of PV/PCM and hybrid PV/T/PCM systems, quantifying payback periods, and lifecycle efficiency gains, thereby clarifying the conditions under which these systems become financially viable and provide insights into future research directions. The review concludes with recommendations for advancing PV cooling technologies. The originality of this study lies in its systematic approach to classifying and evaluating cooling techniques, as well as its detailed comparison of PCM-based cooling with alternative methods. This contribution is expected to significantly advance the understanding and development of PV cooling technologies.

### 1.1. Working Principle of Photovoltaic (PV) Cell

When a photovoltaic (PV) cell is exposed to sunlight, it absorbs solar radiation, generating electron-hole pairs in the depletion region. These charge carriers are driven by internal electric fields, resulting in the production of a photocurrent ( $I_{ph}$ ). This photocurrent flows in the opposite direction of the forward dark current and persists even without an externally applied voltage, commonly referred to as the "short-circuit current". Generation of more electron-hole pairs increases with greater light absorption, making photocurrent directly proportional to light intensity. This phenomenon is known as the photovoltaic effect, and a p-n junction exhibiting this effect is called a solar cell. Figure 1 illustrates the equivalent circuit of a PV cell, and output current ( $I$ ) of cell model is given by Equation (1)<sup>29</sup>.

$$I = I_{ph} - I_D \left[ \exp \left( \frac{V + R_{se} \cdot I}{A \cdot K \cdot T_{PV}} - 1 \right) - \frac{V + R_{se} \cdot I}{R_{sh}} \right] \quad (1)$$

Here,  $I_{ph}$ ,  $I_D$ ,  $R_{sh}$  and  $R_{se}$  are photocurrent, inverse saturation current, shunt resistance and series resistance,

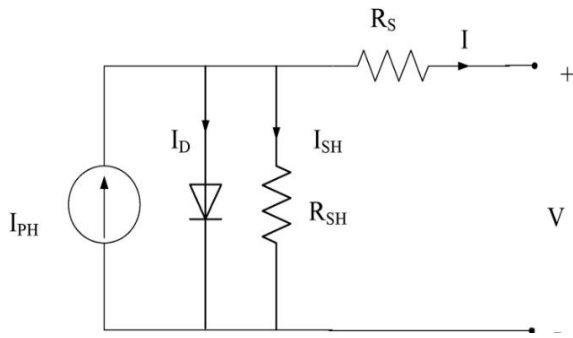

Fig. 1: Equivalent circuit of PV cell<sup>29)</sup>

respectively. Performance of solar PV panel is affected by various factors such as panel material, solar irradiance intensity, panel temperature, azimuthal angle, inclination angle, dust deposition density and wind speed as shown in Figure 2<sup>30,31)</sup>

Among these factors, temperature plays a dominant role in reducing efficiency due to the inherent characteristics of PV materials that transform sunlight into electricity. PV cells utilize the solar spectrum ranging from 700 to 1100

nm to generate electrical energy, while other wavelengths are either reflected or transmitted through panel, eventually converting into heat. This process raises solar cell temperature beyond its standard operating level<sup>32)</sup>. This study investigates the impact of temperature on the performance of PV systems and different cooling techniques for resolving problem of decreased efficiency due to temperature rise.

### 1.2. Effect of Temperature on Photovoltaic Cell Performance

Only a portion of the total solar radiation striking a solar cell is converted into electricity, while rest is transformed into thermal energy. Some of this thermal energy increases the temperature of PV cell, while remainder is dissipated from both top and bottom surfaces. Electrical performance of solar cells is rated under standard test conditions (STC) of 1000 W/m<sup>2</sup> and 25°C. When the temperature of the solar cell exceeds 25°C, its electrical performance declines. An increase in cell temperature results in an increase in short circuit current (ISC) and a decrease in open circuit voltage

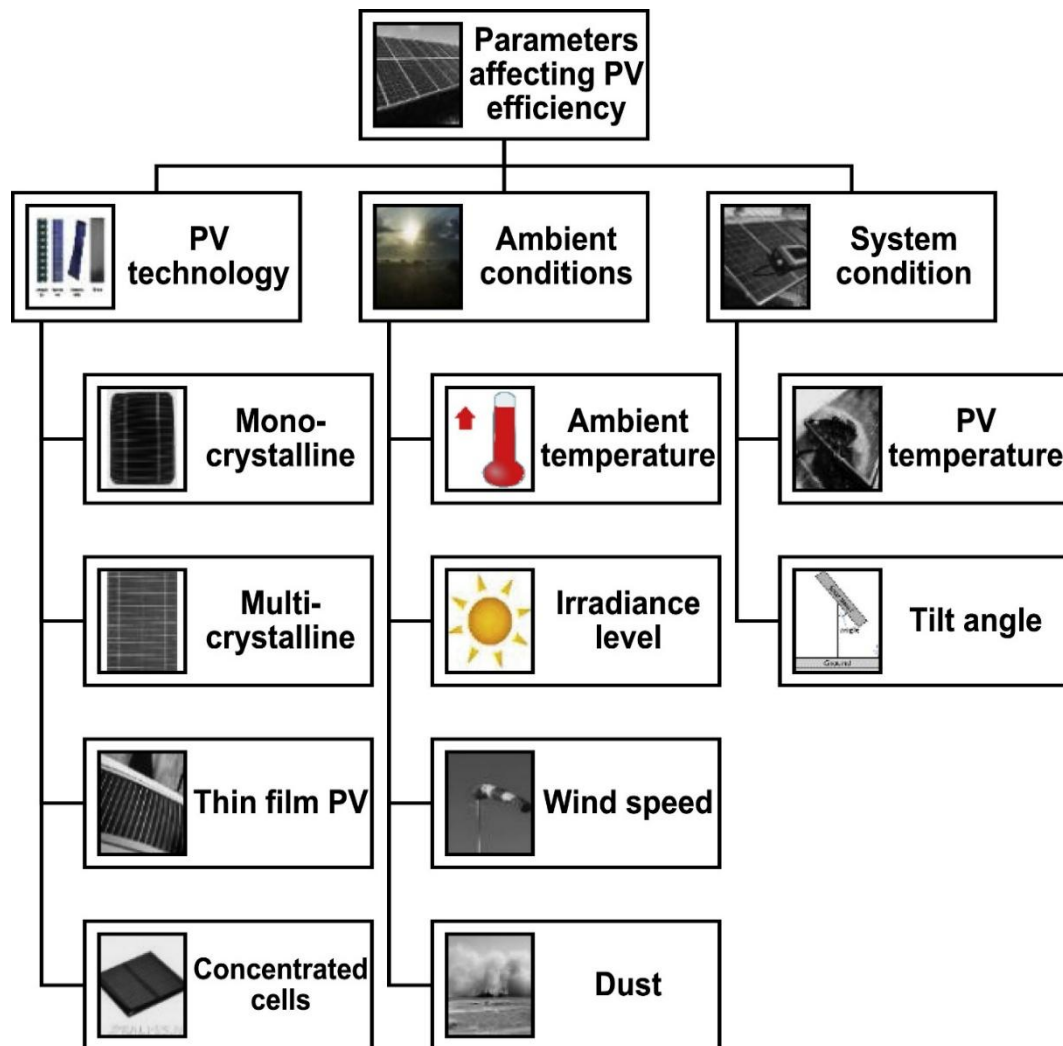

Fig. 2: Parameters affecting the performance/efficiency of PV panel<sup>30)</sup>

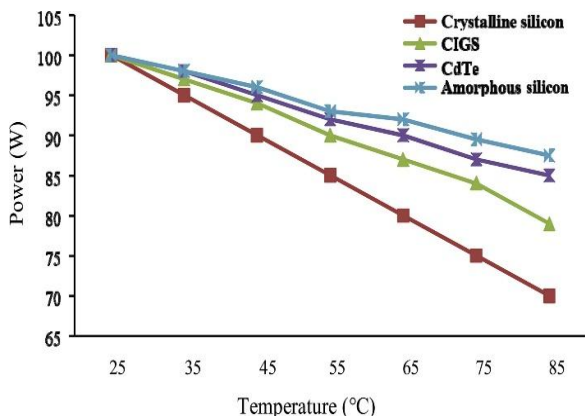

Fig. 3: Effect of temperature on different PV materials<sup>18)</sup>

(VOC). Reduction in VOC is more noticeable than increase in ISC. As a result, as working temperature rises, power output and efficiency of solar cell decrease. Deterioration of electrical performance of solar cells varies depending on type of solar cell. In case of crystalline silicon (Si) cells, an increase of 1°C above 25°C results in a voltage drop of 2.3mV, along with a reduction in power output and efficiency by 0.45% each<sup>33)</sup>. Effect of temperature on power output of PV modules for different PV materials is shown in Figure 3. Electrical efficiency ( $\eta_{elec}$ ), as a function of cell temperature, is given by Equation (2)<sup>34)</sup>

$$\eta_{elec} = \eta_0 [1 - \beta_r \cdot (T_{PV} - T_{STC})] \tag{2}$$

Where,  $\eta_0$  and  $T_{STC}$  are electrical efficiency and temperature of PV cell at STC. While  $\beta_r$  is efficiency of PV cell in (%/°C). To improve the performance of PV cells, appropriate thermal management techniques must be provided to regulate temperature of PV cells. Many researchers have proposed various cooling techniques for solar PV.

## 2. Solar PV Cooling Technology

The primary goal of PV cooling technology is to keep cell temperatures as low as possible by absorbing excessive heat and converting it into usable energy. These technologies are classified as active cooling methods and passive cooling methods. Active cooling methods require extra electric energy to drive coolants (i.e., air and water) to cool PV system. Active cooling systems are more effective than passive cooling systems, although they are typically more expensive. In contrast, passive cooling refers to cooling mediums that are driven by nature, such as air, liquid and PCMs. Some advanced cooling techniques, such as thermoelectric cooling, radiative cooling, heat pipes, and several other cooling strategies, are also used for cooling of PV systems. This section explores different cooling techniques, including both active and passive methods, to lower the temperature of PV

panels and enhance their performance.

### 2.1. Active Cooling Technologies

Active cooling techniques require extra components such as pumps, blowers and fans to flow the coolant such as air, water, and other fluids. While these methods required more energy and additional components, they offer superior cooling performance and higher heat transfer efficiency. The primary advantage of active cooling technology is harvesting of thermal energy rather than generation of electrical output. The main active techniques used for temperature management of PV cells are discussed in the following subsections.

#### 2.1.1. Water/Liquid Active Cooling

High heat-carrying ability and easy availability of water have enabled its use for active cooling of PV panels. Water cooling technologies are more expensive than air-cooled technologies in industrial applications, but they have the potential to extract more heat from PV surfaces, which can be used for process heating, giving it a dual advantage. Abdolzadeh and Ameri<sup>35)</sup> experimentally investigated the effect of spraying water on photovoltaic cells to improve performance of traditional PV panel. Using the spraying method the highest PV cell efficiency increased to 13.5%. Nižetić et al.<sup>36)</sup> improved the performance of PV panels by supplying water to both sides of panel as shown in Figure 4. Experimentally, they achieved a peak increase in electrical output of 16.3% and efficiency of 14.1% under maximum sunlight. Temperature of the PV panel was reduced from 54°C to 24°C. Additionally, the continuous water flow provides a self-cleaning effect, improving both temperature control and overall electrical efficiency of system. In the experiment conducted by Erdogan et al.<sup>37)</sup>, a flowing water film was applied to the solar panel for cooling purposes. The results indicated that the average bottom surface temperatures of the uncooled and cooled panels were 30.09 °C and 28.21 °C, respectively, demonstrating the cooling effect of the water film. The cooling system designed resulted in an average power increase of approximately 9.51%, and overall, the cooled panel was found to be about 13.69% more efficient than the uncooled one.

#### 2.1.2. Air Active Cooling

Air-based cooling methods primarily depend on forced convection heat transfer, where a blower or fan directs airflow through a duct. While air has low heat-carrying capacity compared to liquids, this cooling approach offers benefits such as reduced material usage and lower operational costs. Kaiser et al.<sup>38)</sup> investigated how cell temperature of a BIPV design is affected by air channel size and forced convection. Result indicates that when duct velocity is increased to 6 m/s, the power output improves by 19% compared to the case with natural ventilation at a velocity of 0.5 m/s. Elminshawy et al.<sup>39)</sup> experimentally

Cite: S. Yadav, S. Singh, A. Chaudhary, "Cooling Techniques for Photovoltaic Systems: A Comprehensive Review of Phase Change Materials". Evergreen, 13 (02) 432-454 (2026). <https://doi.org/10.5109/7420062>.

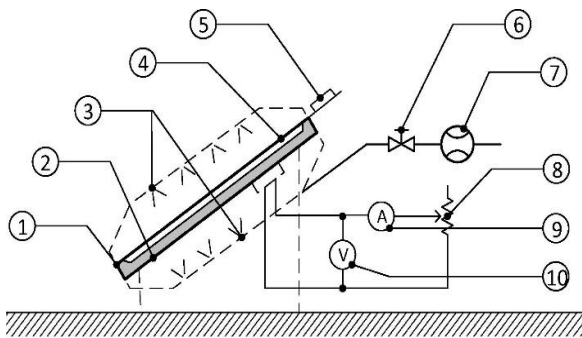

**Legend:**

- |                                |                                 |
|--------------------------------|---------------------------------|
| 1 – photovoltaic panel         | 6 – water flow regulating valve |
| 2 – temperature sensor (back)  | 7 – water flow meter            |
| 3 – nozzles                    | 8 – rheostat                    |
| 4 – temperature sensor (front) | 9 – ammeter                     |
| 5 – pyranometer                | 10 – voltmeter                  |

**Fig. 4:** Schematic layout of the specific experimental setup<sup>36)</sup>

investigated an alternative cooling method for PV panels, designed for the environment of Port Said, Egypt. System utilizes an earth-to-air heat exchanger (EAHE) to pre-cool air before directing it to the back of PV panel. With this approach, PV panel temperature was reduced from 55°C to 42°C at an optimal flow rate of 0.0288 m<sup>3</sup>/s. Consequently, output power and electrical efficiency of the PV panel increased by 18.9% and 22.98%, respectively, at this flow rate. Hussien et al.<sup>40)</sup> studied the characteristics of cooling airflow and temperature distribution on PV panels numerically and experimentally. Two cooling methods were tested: forced air cooling with a blower supplying air through a lower duct, and forced air cooling using small fans placed symmetrically on the backside of the PV panels. Results indicated that temperature of the PV array was reduced by 16.7% with fan cooling and 9.1% with blower cooling. The corresponding maximum output power improvements were 22.4% for fan cooling and 13.2% for blower cooling.

### 2.1.3. Thermoelectric cooling

This approach utilizes the Peltier effect to convert excess heat into electrical energy. Specifically, a thermoelectric generator (TEG) utilizes the temperature difference between its front and back surfaces to generate electricity, with a greater temperature difference resulting in a higher power output. Consequently, this method has been applied to passively cool PV cells, either alone or in combination with other cooling methods. Li et al.<sup>41)</sup> experimentally investigated a novel hybrid PV Thermoelectric (PV/TE) system that integrates a micro-channel heat pipe array during the summer in Hefei, China. The findings show that this hybrid system generates more electrical power compared to a standalone PV module with electrical efficiencies consistently above 14.0% during testing, and PV temperatures approximately 20°C above ambient. Khanalizadeh et al.<sup>42)</sup> introduced a novel integrated PV/T-

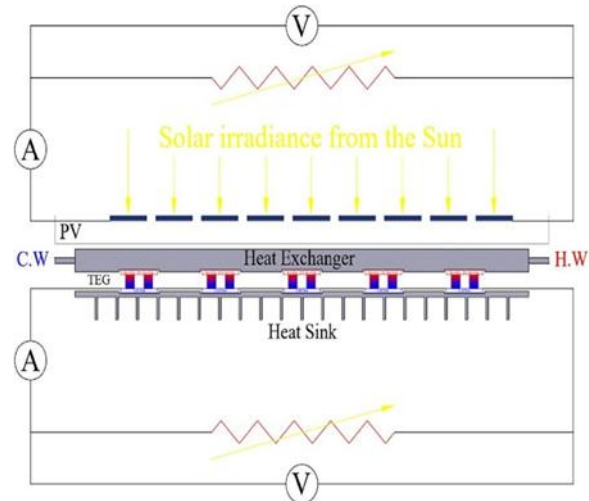

**Fig. 5:** Schematic of hybrid PV-TEC system<sup>42)</sup>

Thermoelectric Generator system designed to enhance PV module performance in hot climates by utilizing both water and air cooling. TEGs are positioned between water heat exchanger and air heat sink as shown in Figure 5. Results showed a 23% reduction in PV temperature, an increase in electrical output by over 15%, and an improvement in electrical efficiency by approximately 3%. Enescu and F. Spertino<sup>43)</sup> also concluded from their analysis of hybrid PV/TEC systems that incorporating thermoelectric cooling (TEC) devices on the backside of a PV module can enhance efficiency of system. The key findings from research on active cooling systems are summarized in Table 1. Notably, Nižetić et al.<sup>36)</sup> achieved the highest temperature drop of 30°C using simultaneous water sprinkling on both sides of PV panel as an active cooling technique.

## 2.2. Passive Cooling Technologies

Passive systems operate without the need for additional power. Passive cooling enables a solar panel to be cooled and prevented from overheating without the need for external forces. As a result, the design is simple and maintenance expenses are less. Therefore, a lot of research on passive cooling has been conducted to develop different novel techniques over the last decades. However, this method is less efficient and slower in terms of cooling. The following subsections discuss several highly effective passive approaches and their effects on cell performance.

### 2.2.1. Liquid/ Water Passive Cooling

To improve the performance of PV module, a simple passive cooling system with cotton wick structures in the presence of water, Al<sub>2</sub>O<sub>3</sub>/water, and CuO/water nanofluid was investigated by Chandrasekar et al.<sup>44)</sup> Figure 6 shows the layouts of the front and back sides with wick structure of PV panel. Results indicated a 30% reduction in maximum cell temperature of PV panel integrated with watered cotton wick structure compared to without cooling due to moist environment on the backside of PV panel.

Additionally, the cotton wick was tested with both CuO/water and Al<sub>2</sub>O<sub>3</sub>/water nanofluid, and a reduction of 11% and 17% in cell temperature was observed. Maximum panel efficiency was 10.4% for water, 9.7% for CuO/water, and 9.5% for Al<sub>2</sub>O<sub>3</sub>/water with wicks, compared to 9.1% without cooling. In another study, Salem et al.<sup>45)</sup> examined the performance of a PV/T system using an aluminum cooling plate with both straight and helical channels, comparing it to an uncooled panel. Findings revealed that PV/T system achieved a boost in electrical efficiency ranging from 17.7% to 38.4% compared to the uncooled panel across a flow rate from 0.25 to 1 L/min. Additionally, thermal efficiency improved from 31.6% to 47.2% for the straight channels and from 34.6% to 57.9% for the helical channel configuration. Alktrane et al.<sup>46)</sup> conducted both experimental and numerical studies on the cooling effectiveness of a hybrid photovoltaic/thermal (PV/T) system using CuO and Fe<sub>2</sub>O<sub>3</sub> nanofluids at volume fractions of 0.2% and 0.3%, circulated through a heat exchanger placed behind the PV module. This cooling method reduced PV cell temperatures by 23.49% and 34.58% with 0.3% concentrations of CuO and Fe<sub>2</sub>O<sub>3</sub> nanofluids, respectively. Compared to an uncooled PV module, electrical efficiency increased by 9.21% with CuO and 10.30% with Fe<sub>2</sub>O<sub>3</sub>, while thermal efficiency saw improvements of 38.9% and 43.3% with CuO and Fe<sub>2</sub>O<sub>3</sub>, respectively.

### 2.2.2. Passive cooling with air

A novel passive air cooling system for PV panel was developed and investigated by Zou et al.<sup>47)</sup>. Results showed that temperature of PV panel can reduce by approximately 10°C when exposed to a solar intensity of 500 W/m<sup>2</sup>. As the intensity increases to 800 W/m<sup>2</sup>, the temperature reduction exceeds 15°C compared to a standard PV panel due to more convection and radiation heat transfer at higher solar irradiation. Mankani et al.<sup>48)</sup> investigated cooling effectiveness of air-cooled heat sinks for Dubai’s climate using CFD. They conducted a step-by-step optimization study to assess the impact of changes in fin spacing, base plate thickness, fin height, and fin thickness on the heat transfer rate. They also analyzed the impact of using aluminum as the heat sink material. At an ambient temperature of 42°C, the initial heat sink model reduced PV cell temperatures by 27°C. Optimizing the fin spacing, base plate thickness, fin height and fin thickness to 7 mm, 0.0025 m, 0.12 m, and 0.002 m respectively, led

to additional temperature reductions of 3.5%, 4%, and 9%. Grubišić Čabo et al.<sup>49)</sup> conducted a techno-economic and environmental assessment of a 260 Wp polycrystalline silicon PV system with passive cooling, using data from a field study in Mediterranean climate conditions. In this study, passive cooling was achieved by attaching perforated aluminum fins to the back of the PV panel. The performance of this passively cooled system was compared to a non-cooled system of identical size, showing that the proposed cooling method could increase power output by up to 5%.

### 2.2.3. Radiative cooling

Radiative cooling is a highly promising passive cooling technology for enhancing photovoltaic (PV) performance without external energy. By utilizing selective spectral thermal radiation in the infrared range (8–13 μm), this approach dissipates heat from PV modules into the atmosphere without reabsorption. Advanced radiative cooling materials, particularly those integrated into glass covers, have shown potential in improving heat dissipation. However, limitations like emissivity valleys within the atmospheric window can affect cooling efficiency. Radiative material films offer a viable solution by effectively dissipating heat without obstructing sunlight, making them an attractive option for PV cooling in hot climates. Pinto et al.<sup>50)</sup> conducted a study using microstructured glass samples, which were characterized for their ability to reduce reflectance and significantly enhance emissivity within the atmospheric window (AW) as illustrated in Figure 7. These glass samples were subsequently laminated onto PV cells and deployed outdoors without a convection barrier. The recorded average temperature differences between two samples were 0.8°C on sunny days, 0.7°C on partly cloudy days, and 0.1°C on cloudy days, with a peak temperature difference of 2.0°C. Wang et al.<sup>51)</sup> introduced a periodic pyramid-textured polydimethylsiloxane (PDMS) film designed to enhance the radiative cooling of encapsulated silicon solar cells. Spectral analysis revealed that textured PDMS film exhibits blackbody-like emission characteristics while maintaining an average transmittance of over 0.9 across silicon absorption spectrum (0.3 to 1.1 μm). Outdoor cooling experiments demonstrated that silicon solar cells encapsulated with the textured PDMS film achieved a temperature reduction of more than 2°C.

**Table 1:** Summary of review focused on active cooling techniques

Cooling Type	Technology Implemented	Temperature Reduction	Performance Improvement	Author(s)
Water Active Cooling	Spraying water over the PV cells	23 °C	3.26% increase in mean cell efficiency	Abdolzadeh and Ameri <sup>35)</sup>
Water Active Cooling	Simultaneous water sprinkle on both sides of PV panel	30 °C	peak increase in electrical output of 16.3% and panel	Nižetić et al. <sup>36)</sup>

Cite: S. Yadav, S. Singh, A. Chaudhary, "Cooling Techniques for Photovoltaic Systems: A Comprehensive Review of Phase Change Materials". Evergreen, 13 (02) 432-454 (2026). <https://doi.org/10.5109/7420062>.

Water Active Cooling	Water flowing front side of the PV	1.88 °C	efficiency of 14.1% 9.51% and 13.69% increase in power output and efficiency	Erdogan et al. <sup>37)</sup>
Water Active Cooling	Converging channel heat exchanger	26.1 °C (June) 11.9 °C (December)	35.5% and 36.1% increase in power output and conversion efficiency	Baloch et al. <sup>52)</sup>
Water Active Cooling	Hybrid PVT water collector	11 °C	9% increase in electrical efficiency	Bahaidarah et al. <sup>53)</sup>
Air Active Cooling	BIPV		19.13% increase in output power	Kaiser et al. <sup>38)</sup>
Air Active Cooling	PV panel cooled by geothermally cooled ambient air	13°C	18.9% and 22.98% increase in power output and efficiency	Elminshawy et al. <sup>39)</sup>
Air Active Cooling	Forced air cooling with a Blower and with fans	5.4 °C 9.4 °C	13.2% and 22.4% increase in output power for blower and fan cooling	Hussien et al. <sup>40)</sup>
Air Active Cooling	PV panel cooling by an air channel underneath the panel	15 °C	Up to improvements 15% in electrical power	Mazón-Hernández et al. <sup>54)</sup>
Air Active Cooling	PV front surface cooling by a direct current fan Hybrid Photovoltaic-	7°C	7.43% and 6.84% increase in power output and efficiency	Nabil and Mansour <sup>55)</sup>
Thermoelectric cooling	Thermoelectric system integrated with micro-channel heat pipe array		5.15% increase in electrical efficiency	Li et al. <sup>41)</sup>
Thermoelectric cooling	Photovoltaic/Thermal-Thermoelectric Generator integrated system that utilizes both water and air cooling	10 °C	15% and 3% increase in power output and efficiency	Khanalizadeh et al. <sup>42)</sup>
Thermoelectric cooling	Incorporated thermoelectric cooling (TEC) devices on the backside of a PV module	10 °C	23% increase in electrical efficiency	Enescu and F. Spertino <sup>43)</sup>

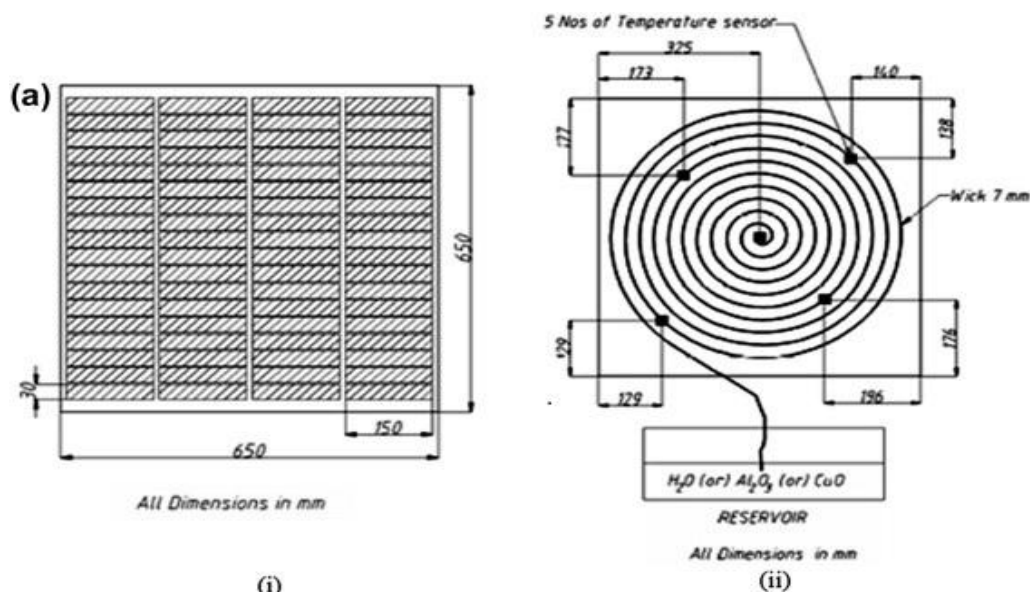

Fig. 6: Layouts of the PV module (i) front side and (ii) rear side with wick structure<sup>44)</sup>

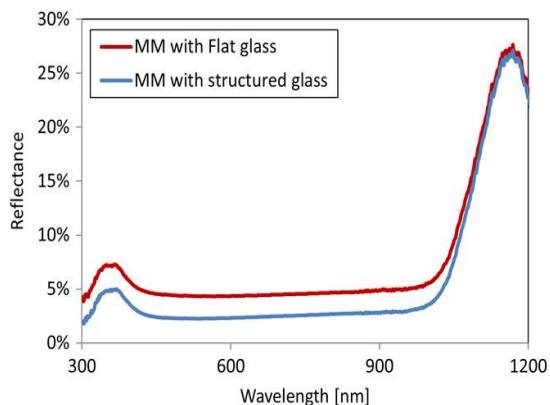

Fig. 7: Spectral reflectance of mini-modules (MM)<sup>50)</sup>

#### 2.2.4. Heat pipe

Integrating heat pipes into PV panels effectively addresses uneven temperature distribution, making it a reliable method for consistent PV cooling. This technique leverages a fluid within heat pipe to capture and dissipate heat through evaporation and condensation. Heat pipes efficiently transfer large amounts of heat across long distances without any moving components, operating as passive thermal systems with low thermal resistance. When heat is supplied to one side, the fluid evaporates and moves to the cooler side, where it condenses and releases the absorbed heat. This two-phase heat transfer enables high-capacity thermal energy transmission, making it ideal for cooling PV cells. Emam et al.<sup>56)</sup> proposed and experimentally investigated combined PV and heat pipe system incorporating an innovative heat sink with an elliptical cross-section and varying aspect ratios, as illustrated in Figure 8. Indoor experiments assessed the effects of different working fluids, charging ratios, and heat loads simulating solar irradiance. The system reduced PV module temperatures by 9–16.36°C and increased output power by 4–8.18%, depending on working fluid, charge ratio, and operating temperature. Kargaran et al.<sup>57)</sup> developed an innovative three-dimensional oscillating heat pipe to enhance cooling of PV panels using graphene oxide nanofluid and distilled water as coolants. Their study demonstrated that using graphene oxide nanofluid lowered the panel temperature by 8.6 °C and boosted power output by 2.78 W during peak heat.

#### 2.2.5. Passive Cooling With Phase Change Materials

Phase change materials are substances with a high latent heat of fusion, which melt and solidify within a narrow temperature range while effectively storing and releasing substantial amounts of heat. Due to these characteristics, PCMs are utilized in thermal management application where they absorb excess heat during peak duty cycle and then release it to surrounding during off cycle hours. Some common applications in this category are thermal management of batteries, electronic components, green

buildings, and solar photovoltaic cooling. Wongwuttanasatian et al.<sup>58)</sup> developed a heat sink finned container using palm wax to enhance solar panel performance. As shown in Figure 9, they tested three container types: groove, finned, and tube, and found that finned containers offered highest cooling capacity. When compared to a non-cooled panel, finned container reduced temperature from 57.9°C to 51.8°C. This resulted in a 4.8% enhancement in performance and a 5.3% rise in PV panel efficiency. Rajvikram et al.<sup>59)</sup> introduced an innovative technique to enhance performance of PV panels by integrating PCM and an aluminum sheet as thermal conductive enhancers (TCE). Experimental results confirm that PV-PCM with aluminum sheet increased efficiency of panel by 24.4%. Furthermore, a 10.35 °C average temperature decrease resulted in a 2% improvement in electrical efficiency. Li et al.<sup>60)</sup> developed a PV/PCM system by attaching a PCM to the back of a PV module. Additionally, they explored a PV/PCM/T system, which integrates a solar thermal (ST) collector to further utilize the heat stored in the PCM, for comparison purposes. The findings indicate that the PV/PCM system reduced PV temperature by up to 23°C compared to a PV-only setup, resulting in a 5.18% increase in electricity output. The key findings from research on passive cooling systems are summarized in Table 2. Notably, Rajvikram et al.<sup>59)</sup> achieved a maximum improvement in power output of 30 % by integrating PCM and an aluminum sheet at the back of PV module as a passive cooling method.

The standout feature of PV/PCM system compared to other cooling technologies is high latent heat storage capacity of PCM. Since PCMs can absorb heat without significant temperature increase, they can retain cooling for extended periods without requiring external energy or moving parts. This makes PV/PCM systems generally more effective than other passive cooling solutions and less costly in terms of maintenance than active cooling systems. Additionally, as long as PCM is recycled, PV/PCM systems have no significant environmental impact. However, the economic viability of PV/PCM systems remains limited, primarily due to the high cost of PCMs, which results in higher initial investment. Since extra electricity produced by PV panel is not sufficient to offset cost of integrating PCMs, efforts are needed to either reduce PCM costs or increase the energy output. On one hand, PCM costs could be lowered through industrial production. On the other hand, integrating PV/PCM systems with PV/T technology to further utilize thermal energy is being explored. Additionally, integrating PV/PCM modules into building walls could enhance the economic feasibility of these systems by lowering energy consumption of building. In this next section basics of PCMs, classifications, properties, selection criteria of PCMs and their application in thermal management of solar PV panel have been presented.

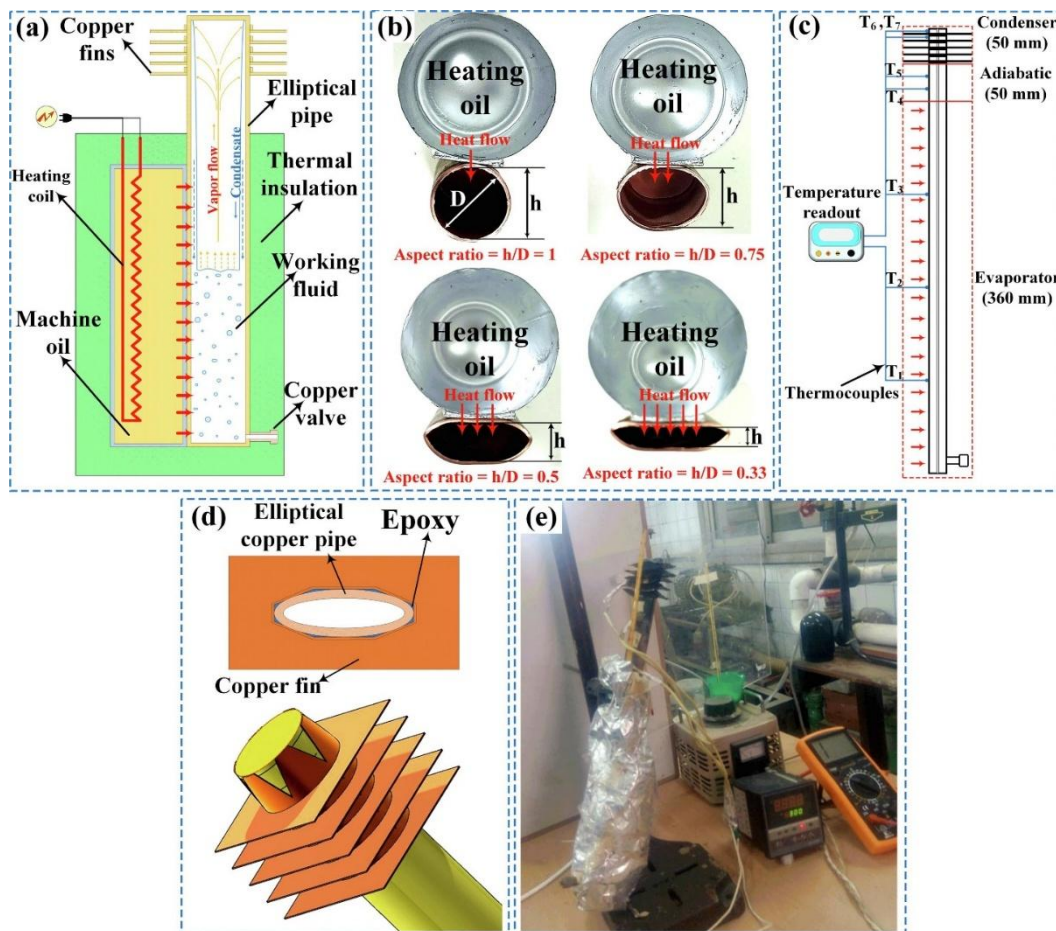

Fig. 8: (a) Schematic diagram of the experimental setup, (b) Heat pipes design with various aspect ratios, (c) locations of thermocouples and (d) Rectangular fin fixation (e) Actual experimental setup<sup>56)</sup>

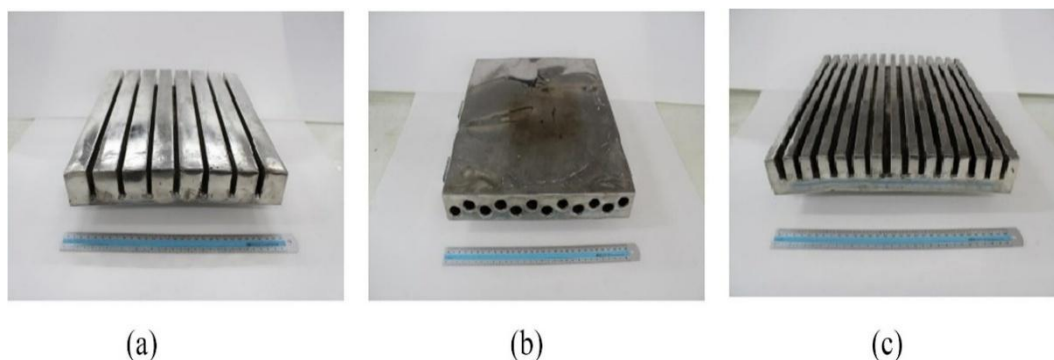

Fig. 9: PCM heat sinks: (a) grooved container. (b) Tubed container, (c) finned container<sup>58)</sup>

Table 2: Summary of review focused on passive cooling techniques

Cooling Type	Technology Implemented	Temperature Reduction	Performance Improvement	Author(s)
Water Passive Cooling	Diffusion of fluid by cotton wicks on PV panel backside	20 °C	15.5% increase in electrical efficiency	Chandrasekar et al. <sup>44)</sup>
Water Passive Cooling	PVT system using an aluminum cooling plate with both straight and helical channels	17 °C (straight channels) 18 °C (helical channels)	31.1% and 38.4% increase in electrical efficiency for straight and helical channels	Salem et al. <sup>45)</sup>
Nanofluid Passive	Serpentine tubes with copper absorbent plate on the back of	24 °C (CuO) 30 °C (Fe <sub>2</sub> O <sub>3</sub> )	9.21% and 10.3% increase in electrical efficiency for CuO	Alktranee et al. <sup>46)</sup>

Cooling	the PV module		and Fe <sub>2</sub> O <sub>3</sub> nanofluids	
Passive air cooling	Passive air cooling system	10 °C		Zou et al. <sup>47)</sup>
Passive air cooling	Optimization of base heat sink for passive PV cooling	4 °C	0.18% increase in power output and efficiency	Mankani et al. <sup>48)</sup>
Passive air cooling with fins	Backside Aluminum fins for PV cooling	14 °C	5% increase in power output	Grubišić Čabo et al. <sup>49)</sup>
Radiative cooling	Microstructured borosilicate glass through dry etching on their external surface	2 °C	1.31 % increase in power output	Pinto et al. <sup>50)</sup>
Radiative cooling	Transparent uniform PDMS with pyramidal periodic texture	2 °C		Wang et al. <sup>51)</sup>
Radiative cooling	Polymeric coverings made of PET and PDMS	1.15°C (PET) 1.35°C(PDMS)		Alshammari et al. <sup>61)</sup>
Heat Pipe	PV-integrated elliptical heat pipe with varying aspect ratios	16.36 °C	8.18 % increase in power output	Emam et al. <sup>56)</sup>
Heat Pipe	Red copper tube-based oscillating heat pipe with graphene oxide nanofluid and distilled water	8.6 °C	10 % increase in power output	Kargaran et al. <sup>57)</sup>
PCM Passive Cooling	Heat sink finned container integrated with palm wax as PCM	6.1 °C	5.3% increase in panel efficiency	Wongwuttanasatian et al. <sup>58)</sup>
PCM Passive Cooling	OM-29 PCM and aluminum plate	10.35 °C	30% increase in power output	Rajvikram et al. <sup>59)</sup>
PCM Passive Cooling	The rear surface of the PV panel is filled with Paraffin wax	23 °C	5.18 % increase in power output	Li et al. <sup>60)</sup>

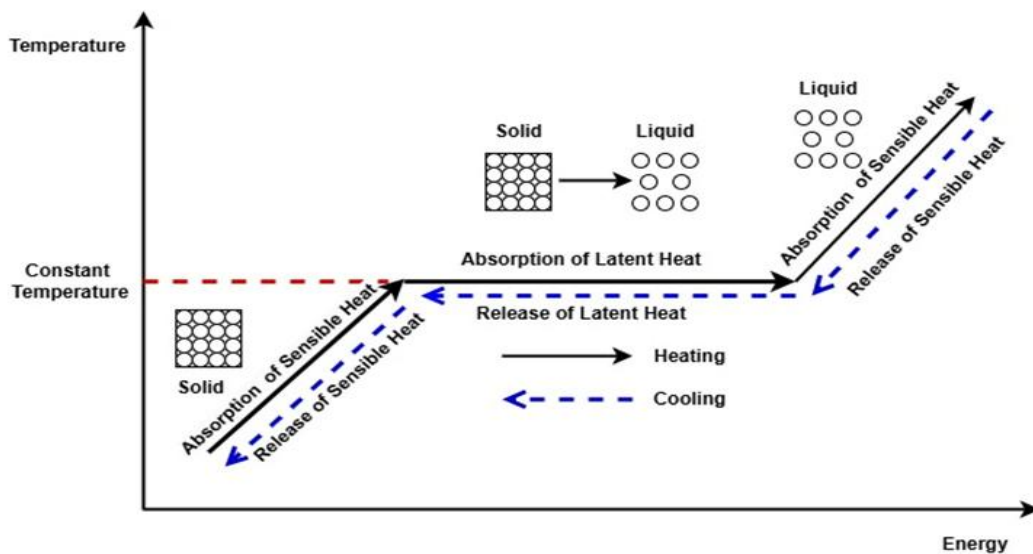

Fig. 10: Ideal variation of temperature of PCM during heating and cooling processes<sup>62)</sup>

### 3. Basics of Phase Change Materials

Thermal energy storage (TES) systems retain energy in the form of heat for future use. Generally, TES systems operate through three key processes: thermal charging, storage, and discharging. Materials can absorb heat in three forms that includes sensible heat, latent heat and chemical reactions. The materials used for latent heat energy storage are called phase change materials. Since PCMs can absorb and release significant amount of latent heat during phase

transitions, they have desirable thermal storage characteristics. These materials remain at the same temperature throughout the phase transition process. Figure 10 shows a schematic diagram of ideal variation of temperature of PCM during absorption and release of heat. Sensible and latent heat contained in PCM can be calculated from Equations (3) and (4)<sup>62)</sup>.

$$Q_s = mc_p \Delta T \tag{3}$$

Cite: S. Yadav, S. Singh, A. Chaudhary, "Cooling Techniques for Photovoltaic Systems: A Comprehensive Review of Phase Change Materials". Evergreen, 13 (02) 432-454 (2026). <https://doi.org/10.5109/7420062>.

$$Q_l = mh_{fg} \quad (4)$$

Where  $m$  is mass,  $Q_s$  is sensible heat,  $\Delta T$  is temperature difference,  $Q_l$  is latent heat and  $h_{fg}$  is specific latent heat.

### 3.1. Classification of Phase Change Materials

PCMs can be classified into three groups namely, organic PCMs, inorganic PCMs, and eutectic PCMs as defined by Kumar et. al.<sup>63</sup>. Figure 11 shows a block diagram for classification of PCMs. Organic and inorganic PCMs are commonly utilized in thermal energy storage. Organic PCMs include paraffin, non-paraffin and fatty acids. Among organic PCMs, paraffin wax and fatty acids are most widely used due to their favourable thermophysical properties, such as high latent heat, minimal or no supercooling, affordability, and recyclability. However, a major drawback of organic PCMs is their relatively low thermal conductivity. Inorganic PCMs consist of metallic PCMs and salt hydrates, with salt hydrates being the most suitable for thermal energy storage applications. They are more cost-effective than paraffin-based PCMs and offer higher latent heat of fusion along with minimal volume changes during phase change. However, salt hydrates present challenges, such as corrosion, instability due to dehydration during thermal cycling, supercooling, inconsistent melting, and phase segregation. Eutectic PCMs are homogeneous mixtures that melt or solidify at a single temperature lower than the melting points of their individual components. These can be classified into Organic-Organic, Organic-Inorganic, and Inorganic-Inorganic eutectics. This mixture melts and solidifies evenly, without separating its components. Thermophysical properties of commonly used PCMs in PV/PCM configurations are shown in Table 3.

### 3.2. Selection Criteria of Phase Change Materials

Selection criteria of PCM for a particular application require some specific properties of material and economics to be fulfilled. Yang et. al.<sup>64</sup> have proposed criteria for selecting the appropriate PCM, as shown in Figure 12. These include thermodynamic properties, chemical properties, economic properties and kinetics, as given below.

**Phase change temperature:** Phase change temperature is a key factor that should be within desirable operating range of the system's required temperature. Equation 5 presents a PCM melting temperature selection criterion for PV panel thermal management, as suggested by Velmurugan et al.<sup>65</sup>.

$$3 + T_{amb} \leq T_{melt} \leq 6 + T_{amb} \quad (5)$$

**Latent heat:** Latent heat is the energy absorbed or released during a phase change. PCMs should have a high latent

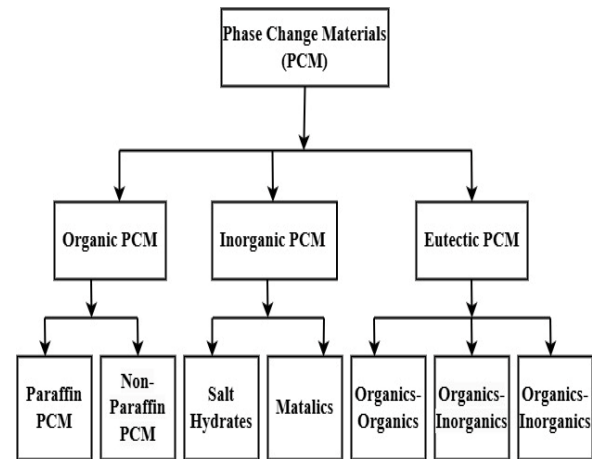

Fig. 11: Block diagram for classifications of PCMs<sup>64</sup>

heat capacity to store more energy within the same mass.

**Thermal conductivity:** A high thermal conductivity ensures that heat absorbed or released during phase change is evenly distributed throughout the material, leading to faster charging and discharging rates<sup>66</sup>. Various methods can enhance thermal conductivity, including the incorporation of highly conductive nanoparticles, use of metal foams, or addition of fins. Li et al.<sup>67</sup> reported that with dispersion of 10 wt.% expanded graphite (EG) into organic PCM, Stearic acid (SA) improves thermal conductivity of pure SA by 13.7 times.

**Volume expansion coefficient:** PCMs experience a phase change between solid and liquid states. Since densities of these phases differ, volume of PCM in its melted state varies from its solid state. Significant volume changes can create challenges in designing PCM-based storage devices. Thus, PCMs with a lower volume expansion coefficient are preferred.

**Low subcooling:** Subcooling is an undesirable property that affects efficient use of PCM. Its effects are observed during cooling of PCM, where PCM does not freeze at solidification point but requires subcooling before solidification begins<sup>68</sup>. PCM should have no/low subcooling tendency. Subcooling will interfere proper heat extraction from melted PCM.

**Stability:** In many PCMs, the properties change over repeated phase change cycles. For instance, undergoing multiple phase change cycles can decrease the latent heat of the PCM. Hence, it is essential for PCM to possess high physical and chemical stability. Vasu et al.<sup>69</sup> investigated the effects of repeated thermal cycling on paraffin wax. Over 200 cycles, they observed significant degradation in key properties, including a 25.17% decrease in latent heat capacity, a 33.72% reduction in peak degradation temperature. However, thermal conductivity increased by 12% after cycling, highlighting its altered behavior under repeated use.

**Costs:** PCM costs should be as low as possible and available in large quantities.

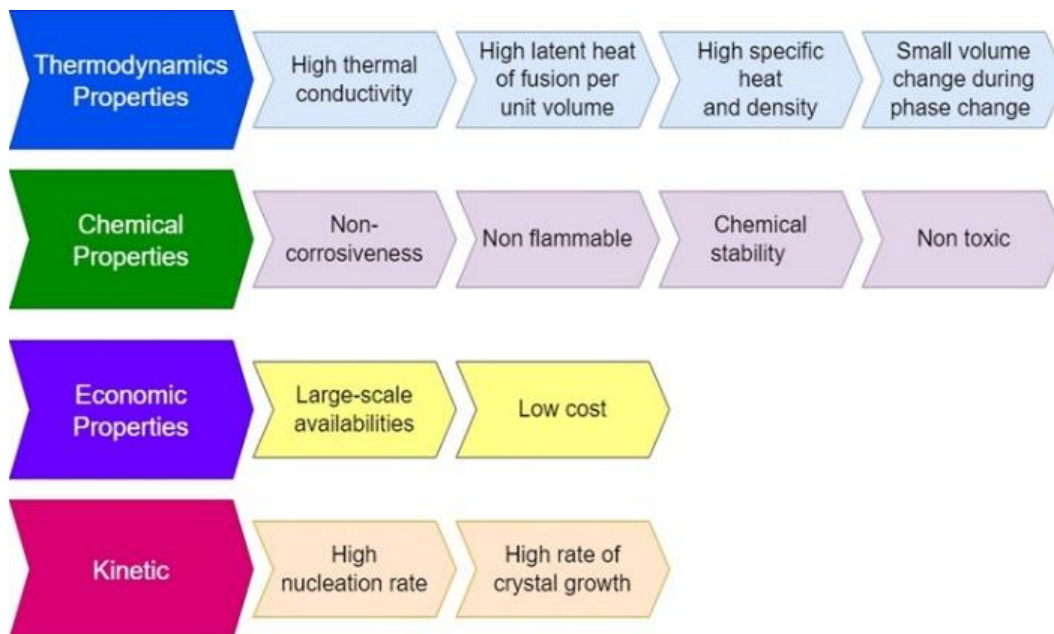

Fig. 12: Selection criteria of PCM<sup>(64)</sup>

#### 4. Application of PCMs in Thermal Management of Solar Photovoltaic Panels

Due to high latent heat capacity of PCM, it can absorb a significant amount of heat from PV panels. As a result, PCMs are widely employed in thermal management of solar PV panels and passive heat storage systems. Due to low thermal conductivity of PCM, its heat transfer rate is low. The rate of heat transfer from a solar panel can be enhanced by using metallic fins, nanoparticles, or encapsulation. Numerous studies have explored the performance of PV panels integrated with PCMs for cooling. Both numerical and experimental analyses have been conducted to examine the influence of PCM physical properties, ambient conditions, and the design of PCM containers.

Amalu and Fabunmi<sup>(70)</sup> numerically analyzed the use of Docosane (C<sub>22</sub>H<sub>46</sub>) paraffin wax for cooling of PV modules in hot conditions. The PCM reduced peak cell temperatures from 76.7 °C to 43.0 °C under maximum heat flux (1000 W/m<sup>2</sup>), achieving a 72.4% reduction. The average cell temperatures were also lowered from 48.2 °C to 43.4 °C, enhancing efficiency of PV module by 10.88%. Akshayveer et al.<sup>(71)</sup> conducted a numerical analysis of a bifacial PV/PCM system featuring a bifurcated thermal energy storage PCM enclosure placed between two PV panels as shown in Figure 13. The modified BIF-PV/PCM system demonstrated a 77% higher power output compared to PV/PCM system. Additionally, it improved overall system efficiency by 22.38% over BIF-PV/PCM system at 20 mm enclosure thickness. Liang et al.<sup>(72)</sup> experimentally analyzed a novel PVT system using paraffin-coated Microencapsulated Phase Change Material

(MPCM) slurry as the cooling medium as shown in Figure 14. The system featured a snake-like flow passage at the back of the panel. Indoor tests showed an average electrical efficiency of 12.21% with MPCM slurry, slightly higher than using pure water. Outdoor experiments confirmed the superior performance of MPCM slurry, achieving a 0.8% increase in electrical efficiency and a 13.5% rise in maximum thermal efficiency compared to water-cooled systems. Choubineh et al.<sup>(73)</sup> found that incorporating PCM into an air-cooled PV system reduced the backside temperature by an average of 4.3°C, with a maximum reduction of 10°C. This cooling method improved electrical efficiency by at least 9%, demonstrating its effectiveness compared to systems without PCM, where natural and forced convection yielded efficiencies of 11% and 11.5%, respectively.

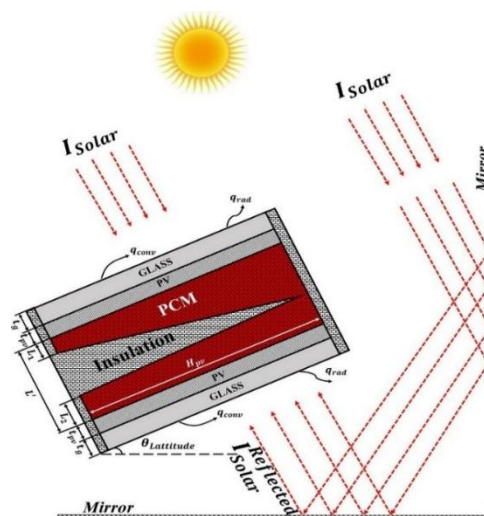

Fig. 13: A modified BIF-PV/PCM system with a bifurcated non-rectangular PCM unit<sup>(71)</sup>

Cite: S. Yadav, S. Singh, A. Chaudhary, "Cooling Techniques for Photovoltaic Systems: A Comprehensive Review of Phase Change Materials". Evergreen, 13 (02) 432-454 (2026). <https://doi.org/10.5109/7420062>.

Akshayveer et al.<sup>74)</sup> conducted a numerical study on PVT/PCM systems, examining the impact of natural convection and PCM melting. The model included an air flow channel above the PV panel and a PCM enclosure below. Compared to a standard PV system, the PV/PCM and air PV/T/PCM systems reduced cell temperatures by 25% and 35%, respectively, and increased electrical efficiency by 14.12% and 19.75%. The results demonstrated that the air PV/T/PCM system offers superior performance over both the PV/PCM and standard PV systems. Singh et al.<sup>75)</sup> investigated the performance of a PCM-integrated PV panel with aluminum containers to enhance conductivity, incorporating expansion tubes to accommodate PCM (CaCl<sub>2</sub>·6H<sub>2</sub>O) expansion during melting. The PCM cooling system reduced maximum panel temperatures by 18.0°C in January and 23.3°C in June. This temperature reduction resulted in daily electricity generation increase of 6.2% in January and 8.3% in June, demonstrating significant performance improvements. Al-Najjar and Mahdi<sup>76)</sup> developed a novel MATLAB-based PV/PCM model utilizing simple numerical functions and RT35 as the PCM as shown in Figure 15(a). The model was validated against CFD simulations and experimental results, achieving an error of 1.4% and a correlation coefficient of 0.999. Findings showed that thermal efficiency increased nearly fivefold as ambient temperature increased from 0 to 35°C but decreased by 55% when wind speed increased from 0 to 4 m/s. Figure 15(b) shows that as the tilt angle increased from 0° to 90°, thermal efficiency improved by 30%, while the melting time decreased by 23%. Biwole et al.<sup>77)</sup> also proposed a numerical model for heat and mass transfer in PCM integrated PV panel. They observed that addition of a PCM to back side of panel can keep panel temperature below 40 °C for 80 minutes at 1000 W/m<sup>2</sup> irradiance. Khanna et al.<sup>78)</sup> investigated thermal performance of PV, PV/PCM, and finned-PV/PCM systems using a mathematical model. Study identified the optimal PCM container depth and fin dimensions to maintain PV temperature within a desirable range under varying solar radiation. Results showed that increasing fin length reduces PV temperature, with the optimal fin length

matching the container depth as shown in Figure 16. While thicker fins also improved cooling, no significant temperature reduction was observed beyond 2 mm thickness. The optimal PCM container depth was determined to be 8 cm for 3 kWh/m<sup>2</sup>/day, with an ideal fin spacing of 25 cm.

Kibria et al.<sup>25)</sup> conducted a numerical study on thermal performance of a PV module integrated with a PCM storage system, using a 1-D energy balance model. They evaluated three PCMs (RT20, RT25, and RT28HC) with different melting points. RT28HC, with a higher latent heat capacity, showed the best performance in reducing PV temperature. However, high-energy-density PCMs like RT25 and RT28HC did not fully melt, highlighting the importance of optimizing PCM chamber size. RT20 fully melted after 480 minutes, while RT25 and RT28HC melted to 80% and 65%, respectively. Elsheniti et al.<sup>79)</sup> introduced a novel 1D enhanced conduction model (ECM) to accurately estimate the PV/PCM interface temperature while significantly reducing computation time. The study concluded that ECM reduces computation time by nearly 360 times, making it a highly effective tool for temperature prediction in PV/PCM systems. Abdelrazik et al.<sup>80)</sup> numerically studied a hybrid cooling system that integrate a PV/PCM system, a PV/T system, and the inclusion of graphene-nanoplates (GNP) in paraffin PCM as shown in Figure 17. The study found that electrical efficiency was greater in winter compared to summer, although the electrical energy output was greater in the summer due to higher solar radiation. The hybrid system improved electrical efficiency by 22% in summer and 6.9% in winter compared to a standalone PV system. Sharma et al.<sup>81)</sup> experimentally studied cooling effects of micro-fins, PCM, and NPCMs in building-integrated concentrated photovoltaics (BICPV). The results showed that un-finned surface reached a peak temperature of 43.6°C with PCM, while micro-finned surface peaked at 41.7°C. Both surfaces maintained temperatures below 41.5°C when n-PCM was used. The study also found that the inclusion of nanomaterials had a more significant effect on surface without fins. The key findings from research on cooling of PV system with PCM systems are summarized in Table 4.

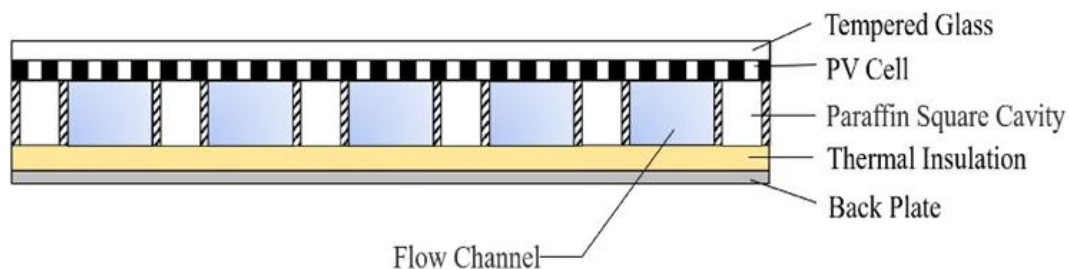
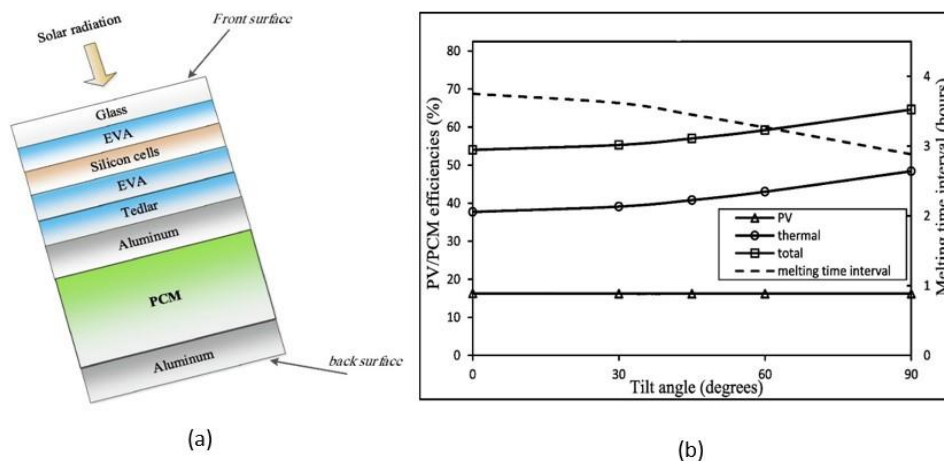

Fig. 14: Schematic diagram of the cross-section of the PVT module<sup>72)</sup>

**Table 3:** Thermophysical properties of commonly used PCMs in PV-PCM configurations

PCM Type	Melting Point (°C)	Latent Heat (kJ/kg)	Density (m <sup>3</sup> /kg)	Thermal Conductivity (W/m.K)	Specific Heat (kJ/kg)	Authors
Capric-palmitic acid	22.5	173	S- 870 L-790	S- 0.14 L- 0.14	S- 2 L- 2.3	Hasan et al. <sup>82)</sup>
Paraffin wax	28	210	S- 869 L- 780	S- 0.24 L- 0.15	S- 2.9 L- 2.1	Su et al. <sup>83)</sup>
CaCl <sub>2</sub> .6H <sub>2</sub> O	29.9	191	S- 1710 L- 1560	S- 1.08 L- 0.56	S- 1.4 L- 2.1	Hasan et al. <sup>82)</sup>
Capric: palmitic acid	17.7–22.8	189–191		0.143	1.65	Browne et al. <sup>84)</sup>
Waksol A	32–36	163	S- 770 L- 760	S- 0.33 L- 0.31		Huang et al. <sup>85)</sup>
Paraffin wax	57	200–220	S- 910 L- 810	0.24	S- 2 L- 2.1	Maatallah, et al. <sup>86)</sup>
RT35	S- 29 L- 36	240	S- 870 L- 880	0.2	S- 2 L- 2	Ma et al. <sup>87)</sup>
Paraffin wax	28	210	S- 869 L- 780	S- 0.24 L- 0.15	S- 2.9 L- 2.1	Malvi et al. <sup>88)</sup>
RT27	25–28	184	S- 770 L- 760	S- 0.2 L- 0.2		Huang et al. <sup>85)</sup>
Capric acid	30.1	158	886	0.149	S- 1.9 L- 2.1	Yang et al. <sup>89)</sup>
RT35	35	157	S- 770 L- 760	S- 0.2 L- 0.2		Huang et al. <sup>85)</sup>
Paraffin wax	5–60 °C in 1 °C interval	210	S- 869 L- 780	S- 0.24 L- 0.15	S- 2.9 L- 2.1	Smith et al. <sup>90)</sup>
RT25	26.6	232	S- 785 L- 749	S- 0.19 L- 0.18	S- 1.84 L- 2.4	Nouira et al. <sup>91)</sup>
RT 28	28	245	S- 880 L- 770	0.2	2.0	Stropnik et al. <sup>92)</sup>
RT44	44	250	S- 800 L- 700	L- 0.2 S- 0.2	L- 2 S- 2	Nouira et al. <sup>91)</sup>
OM-29	29	299	S- 868 L- 870	S- 0.293 L- 0.172	S- NA L- 3.9	Rajvikram et al. <sup>59)</sup>
PCM32/80	32	280	1500	0.4		Choubineh et al. <sup>73)</sup>
Pork fat 155-	36-45	170	S- 910 L- 886	S- 0.317 L- 0.412	S- 2.03 L- 2.05	Nizetic et al. <sup>93)</sup>
N Docosane	44	249	S- 912 L- 779	S- 0.21 L- 0.21	S- 1.46 L- 1.46	Motiei et al. <sup>94)</sup>
CaCl <sub>2</sub> .6H <sub>2</sub> O- MgCl <sub>2</sub> .6H <sub>2</sub> O	27.1	171.4		3.359		Yogyichuan et al. <sup>95)</sup>
Polyethylene glycol	38-40	159	1092.7			Baygi et al. <sup>96)</sup>
Paraffin wax (Merck)	42–72	200–220	900		2.14–2.9	Sardarabadi et al. <sup>97)</sup>



**Fig. 15:** (a) Sectional view of the typical PV/PCM system (b) Variation of thermal efficiencies and melting time with tilt angle<sup>76)</sup>

Cite: S. Yadav, S. Singh, A. Chaudhary, "Cooling Techniques for Photovoltaic Systems: A Comprehensive Review of Phase Change Materials". Evergreen, 13 (02) 432-454 (2026). <https://doi.org/10.5109/7420062>.

## 5. Life-cycle Cost Analysis

With increasing interest in using PCMs for thermal management to enhance PV system efficiency, conducting cost and feasibility analyses of these systems has become highly significant in the renewable energy sector. While numerous studies have been undertaken by researchers, a lack of comprehensive data for complete analysis remains a challenge. Hasan et al.<sup>98)</sup> evaluated the performance of a PV/PCM system in the hot climate of the UAE, reporting an estimated 5.5% annual increase in electrical output. A cost analysis that included the expense of RT42 PCM indicated an economic benefit of \$2.2/m<sup>2</sup>, though the system had a 10-year payback period. However, this was shortened to 3 years when a more affordable salt hydrate was used as the PCM. The study suggested that economic feasibility of PV/PCM systems could improve further with a decrease in PCM costs, driven by growing interest in this technology. Maatallah et al.<sup>86)</sup> experimentally evaluated performance of solar panels and water-based PV/T/PCM systems. Their analysis, conducted under various outdoor environmental conditions, showed that integrating PCM significantly enhanced system efficiency. Additionally, payback period for PV/T/PCM system was approximately 6 years, based on an overall exergy analysis, which is 11.26% shorter than standalone PV panel. Furthermore, this system demonstrated a 27% higher lifecycle conversion efficiency as compared to conventional PV panels. Hossain et al.<sup>99)</sup> conducted an economic analysis of cash flow and payback period for a standalone PV panel and a PV/T system integrated with a PCM module in Malaysia. The initial costs for a standalone PV panel and a PCM module were MYR 2000 and MYR 5604.53, respectively. Although these costs are high, both systems are maintenance-free. The service lifetimes of the PV panel and PCM module were estimated to be 4 years and 6 years, respectively. When combined, the installation cost of the PV/T system with the PCM module was approximately MYR 1900, with a service lifetime of up to 4 years. Over this period, the cost benefit of the PV/T system with the PCM module was calculated to be MYR 3320.61. This demonstrates that integrating the PCM module can extend the service lifetime of the PV/T system. Al-Waeli et al.<sup>100)</sup> performed an economic analysis using life cycle cost (LCC) method to evaluate component costs and annual energy productivity of four systems: standalone PV system, PV/T system with water, nanofluid, and NPCM-nanofluid. The life cycle costs for these systems were \$568.46, \$774.14, \$1011.89, and \$1288.37, respectively. Their corresponding annual energy productivities were \$141.90, \$164.97, \$209.97, and \$230.73, respectively. The cost of electricity was calculated at \$0.125 per kWh, with payback periods ranging from 5 to 6 years.

The economic and technical viability of PV/PCM systems

has been explored, but analyses often lack precision. High PCM costs, along with shipping, taxes, and import duties, make these systems expensive with long payback periods in conventional PV systems. Feasibility improves when PCMs are integrated into hybrid PV/T systems, utilizing excess heat for thermal energy, reducing costs, and shortening payback periods. Increasing interest in these systems is expected to lower component and material costs, supporting wider adoption of this efficient technology.

The study systematically explores both passive and active cooling methods, highlighting the strengths and challenges of each approach, while underscoring the potential of PCMs as a transformative solution in thermal management. The review consolidates evidence showing that PCM-based cooling effectively reduces PV temperatures by up to 42% and enhances electrical efficiency by 6-22%. However, economic constraints, such as high PCM costs, limit their broader adoption. Comparatively, active cooling methods like water and air systems offer higher thermal efficiency but incur additional energy and maintenance costs, unlike the self-regulating nature of PCMs. The paper provides valuable insights into hybrid systems, such as PV/T and PV/PCM combinations, which leverage both electrical and thermal energy. These hybrid setups demonstrate improved energy output and cost-effectiveness, especially when coupled with advancements like nano-enhanced

Numerous challenges hinder the widespread adoption of PV/PCM systems, including issues such as PCM leakage, degradation during thermal cycling, and limited heat storage capacity. Addressing these obstacles requires advancements in material design and system configurations. Economic barriers, particularly the high cost of PCMs, also pose significant limitations. To overcome these, recommendations include scaling up industrial production of PCMs and integrating them with other technologies to enhance cost-effectiveness. Efforts to optimize PCM properties, develop better encapsulation techniques, and design hybrid systems are crucial. Additionally, exploring PCMs with improved thermal conductivity and durability is recommended.

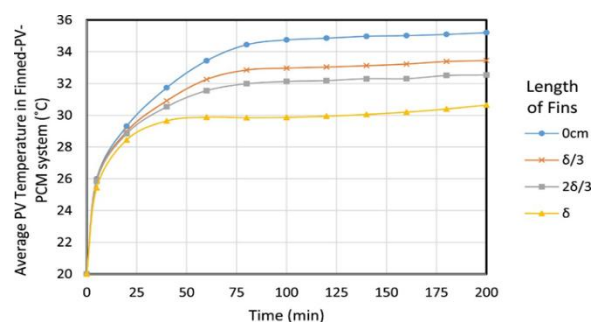

Fig. 16: Variation of PV temperature in Finned-PV-PCM system with time for different lengths of fins<sup>78)</sup>

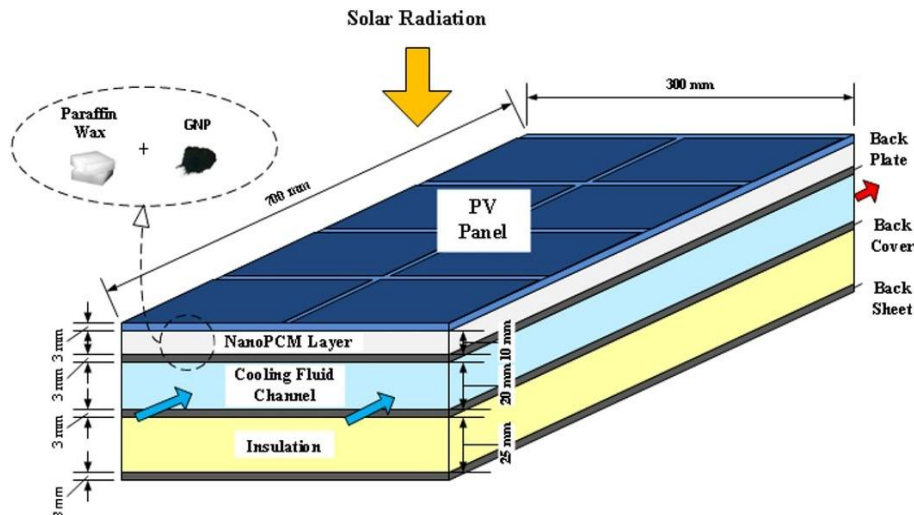

Fig. 17: Schematic diagram for a typical PV/T/nanoPCM system<sup>80)</sup>

Table 4: Summary of literature review of PV system with phase change material

PCM Type	System Configuration	Key Findings	Authors
Docosane (C <sub>22</sub> H <sub>46</sub> )	Numerically investigate the effect of using PCM to control the temperature of c-Si PV module operating in hot climatic conditions.	PV-PCM module reduces cell temperature by 72.4 % at peak heat flux. PV-PCM module improves efficiency PV module by 10.88%.	Amalu and Fabunmi <sup>70)</sup>
RT27	Numerically investigate a bifacial PV/PCM system with sandwiched thermal energy storage enclosure	Electric power output is 77% more in modified BIF-PV/PCM system than L <sub>30</sub> PV/PCM	Akshayveer et al. <sup>71)</sup>
Paraffin	Experimentally investigate a PVT system using paraffin-coated material Microencapsulated PCM slurry	Average electrical efficiency and maximum thermal efficiency of system can be increased by 0.8 and 13.5 %.	Liang et al. <sup>72)</sup>
Salt hydrate (PCM32/280)	Experimentally investigate the effect of using PCM on an air-cooled PVT system.	PVT/ PCM results 10 °C decrease in maximum temperature and 9% increase in electrical efficiency.	Choubineh et al. <sup>73)</sup>
OM32	Numerically investigate effect on PVT/PCM performance due to natural convection and PCM melting from both the sides of PV	PV/PCM system and air PVT/PCM system reduces cell temperature by 25% and 35%. Electrical efficiency increased by 14.12 % and 19.75 %, respectively.	Akshayveer et al. <sup>74)</sup>
CaCl <sub>2</sub> .6H <sub>2</sub> O	Experimentally investigate a PCM integrated PV panel with multiple conductivity-enhancing aluminium containers.	Reduces maximum PV panel temperature by 18.0°C in January and 23.3°C in June. Daily electricity generation increased by 6.2 % in January, and 8.3 % in June.	Singh et al. <sup>75)</sup>
Rubitherm-RT35	Novel PV/PCM model in MATLAB using simple numerical functions and no mesh patterns	Thermal efficiency rises nearly fivefold, but falls by 55% as wind speed rises from 0 to 4 m/s.	Al-Najjar and Mahdi <sup>76)</sup>
RT25	Numerical model for heat and mass transfers in PCM integrated solar PV panel	Addition of PCM to a solar panel can keep the panel temperature below 40 °C for 80 minutes.	Biwole et al. <sup>77)</sup>
RT 25 HC	Mathematical model of PV, PV-PCM and Finned-PV-PCM systems.	Fin length increases, the photovoltaic temperature decreases and the optimal fin length is equal to PCM container depth	Khanna et al. <sup>78)</sup>
RT 20 RT 25 RT 28HC	Numerically investigate a PV module integrated with PCM storage system using a transient one-dimensional energy balance model.	RT20 is completely melted after 480 minutes of operation, while RT25 and RT28HC are melted to 80 % and 65%, respectively.	Kibria et al. <sup>25)</sup>
RT25HC	Novel 1D enhanced conduction model (ECM) that estimates PV/PCM interface temperature accurately while reducing	ECM can reduced computation time by almost 360 times as compare to CFD model.	Elsheniti, et al. <sup>79)</sup>

Cite: S. Yadav, S. Singh, A. Chaudhary, "Cooling Techniques for Photovoltaic Systems: A Comprehensive Review of Phase Change Materials". Evergreen, 13 (02) 432-454 (2026). <https://doi.org/10.5109/7420062>.

computation time			
Capric-palmitic Acid CaCl <sub>2</sub> ·6H <sub>2</sub> O RT20 RT25 RT35	Numerical study on hybrid cooling system combining PV/PCM system and PV/T system and inclusion of nanoparticles in PCM.	Hybrid PV/T/nanoPCM system with 10% nanoparticles loading shows an enhancement of 22% and 6.9% in electrical efficiency as compared to standalone PV system summer and winter, respectively.	Abdelrazik et al. <sup>80)</sup>
RT42	Experimentally investigate the influence of incorporating micro-fins, PCM and n-PCMs for cooling of building integrated concentrated photovoltaics (BICPV).	Both the un-finned and micro-finned surfaces remained below 41.5 °C throughout the experiment when n-PCM was used.	Sharma et al. <sup>81)</sup>
RT21 RT35 RT44	Optimization model using MATLAB and a genetic algorithm to determine the most appropriate PCM for specific climate zones.	RT21 PCM reduced PV panel surface temperature by 42%, improving efficiency by 6% and increasing electrical output by 16%, is most effective among tested PCMs.	Durez et al. <sup>101)</sup>

## 6. Perspectives for Future Research

This review article provides a comprehensive overview of PV thermal management techniques, with a particular focus on cooling methods utilizing PCMs. Research on PV/PCM systems has been ongoing for the past decade; however, their commercialization remains limited due to the low heat capacity and stability of PCMs. Improvements can be achieved by integrating heat extraction mechanisms through photovoltaic/thermal systems with PCM (PV/T/PCM), which offer the potential to meet both thermal and electrical energy needs in a compact design. The literature suggests that performance of PV/T/PCM systems can be further enhanced, paving the way for wider deployment in the future. Notably, photovoltaic/thermal systems with nano-enhanced PCM (PV/T/NPCM) outperform traditional PV/PCM and PV/T/PCM systems, but experimental research on these systems is still limited. The following areas are identified for further investigation:

- **Extensive Experimental Studies:** More experimental research on PV/T/NPCM systems is needed to evaluate their performance under diverse climatic conditions.
- **Long-term Testing:** Current studies are predominantly short-term, yielding positive results. However, long-term endurance tests are essential to overcome the limitations of PCM in thermal management.
- **Nanofluid Integration:** Utilizing nanofluids as working medium in PV/T systems can improve heat transfer between PCM and the thermal system.
- **Nanoparticle Dispersion:** Efficient, agglomeration-free methods for dispersing nanoparticles in PCM are required to enhance system performance.
- **Solidification Considerations:** The solidification process of PCM should be studied alongside melting, as sub-cooling can hinder performance over consecutive days.
- **Economic Analysis:** Comprehensive economic

assessments of PV/T/PCM and PV/T/NPCM systems are needed for their commercialization and industrial adoption.

- **Life Cycle Studies:** Energetic life cycle analyses should be conducted to evaluate environmental impacts.
- **Advancements in Passive Cooling:** Investigating passive cooling methods, including radiative cooling, heat pipe, and innovative PCMs, can support the advancement of self-sustaining PV systems.
- **Hybrid Cooling Methods:** Integrating both active and passive cooling techniques can further improve the efficiency of solar panels.
- **Overcoming Application Barriers:** Focus should shift to overcoming barriers to practical applications of PV/PCM technology, moving beyond theoretical studies, which are already well understood.

The field of PV/PCM technology appears to have reached a bottleneck. Future progress will heavily depend on advancements in PCM research, particularly its dual role in thermal services when integrated into building designs. Emphasizing innovative strategies can help transition this technology from development to widespread practical application.

## 7. Conclusions

This paper provides a comprehensive review of photovoltaic (PV) cooling technologies, with a focus on phase change materials. It explores current research, achievements, limitations, and practical challenges, along with an economic assessment of PV/PCM systems. The review covers various conventional and advanced cooling techniques, facilitating a comparative analysis of performance parameters. The following are the significant findings:

- Active cooling achieves the largest temperature drops (up to 30 °C) and power gains (15–23 %), but

requires parasitic energy.

- Among passive methods, optimized PV/PCM systems deliver temperature reductions of 10–33 °C and power increases of 10–30 % without any energy input, outperforming air/liquid passive cooling (10–27 °C, 10–22 %) and approaching active cooling performance.
- Water cooling, especially in active systems, is highly effective for thermal management. Methods such as spraying water or water film cooling have shown significant efficiency improvements and temperature reductions (e.g., up to 30°C temperature decrease and 36% power output increase). Economic feasibility improves when waste heat is utilized for other applications, such as process heating.
- Passive and active air cooling systems, such as forced convection with blowers or natural ventilation, offer cost-effective cooling but are less efficient than water systems. Optimized setups (e.g., duct velocity at 6 m/s) increase power output by up to 19% and reduce temperature by up to 13°C.
- Radiative Cooling Utilizes infrared emission to dissipate heat, reducing temperatures by 2°C in some cases and promising for integration with PV modules in hot climates.
- Thermoelectric and Heat Pipe Systems offer innovative approaches for PV cooling, achieving temperature reductions up to 16.36°C and increasing electrical efficiency by up to 23%.
- PCM-based passive cooling thus offers the best compromise of performance (10–33 °C reduction, 10–30 % power gain), zero operational cost, low maintenance, and negligible environmental impact.
- Proper selection of PCM with optimal melting points, thermal conductivity and latent heat enhances performance. Integrating PCMs with fins or nanoparticles further boosts thermal conductivity and efficiency.
- Enhanced PCM designs incorporating fins, nanoparticles, conductivity additives commonly achieve efficiency increases of more than 15 %, with effective thermal conductivities that are 5–14 times greater than pure PCM.
- Higher tilt angles enhance natural convection, which significantly affects cooling performance in passive systems. This is a critical factor for designing systems in varying climatic conditions.
- PV/PCM payback periods are 8–10 years due to high material costs, but hybrid PV/T/PCM systems shorten this to 3–6 years, with annual energy productivity up to 62 % higher and lifecycle efficiencies about 27 % higher than conventional PV.
- The use of low-cost PCMs (e.g., salt hydrates) reduces system costs and payback periods from 10 years to as low as 3 years in some applications.
- Cost benefits of integrating PCMs in hybrid PV/T systems include extended service lifetimes and maintenance-free operation, resulting in superior economic performance.
- Innovations like nano-enhanced PCMs or advanced encapsulation designs promise to lower costs while improving efficiency, addressing a significant barrier to widespread adoption.

## Nomenclature

<i>A</i>	Dimensionless junction material factor
<i>BIF</i>	Bifacial
<i>K</i>	Boltzmann constant
<i>L</i>	Liquid
<i>MYR</i>	Malaysian Ringgit
<i>S</i>	Solid
<i>T<sub>amb</sub></i>	Ambient Temperature
<i>T<sub>melt</sub></i>	Melting Temperature of PCM

## References

- 1) A.K. Pandey, M.S. Hossain, V. V. Tyagi, N. Abd Rahim, J.A.L. Selvaraj, and A. Sari, "Novel approaches and recent developments on potential applications of phase change materials in solar energy," *Renew. Sustain. Energy Rev.*, 82 (September 2017) 281–323 (2018). doi:10.1016/j.rser.2017.09.043.
- 2) M. Hasanuzzaman, N.A. Rahim, M. Hosenuzzaman, R. Saidur, I.M. Mahbulul, and M.M. Rashid, "Energy savings in the combustion based process heating in industrial sector," *Renew. Sustain. Energy Rev.*, 16 (7) 4527–4536 (2012). doi:10.1016/j.rser.2012.05.027.
- 3) O. Ellabban, H. Abu-Rub, and F. Blaabjerg, "Renewable energy resources: current status, future prospects and their enabling technology," *Renew. Sustain. Energy Rev.*, 39 748–764 (2014). doi:10.1016/j.rser.2014.07.113.
- 4) R. Wüstenhagen, M. Wolsink, and M.J. Bürer, "Social acceptance of renewable energy innovation: an introduction to the concept," *Energy Policy*, 35 (5) 2683–2691 (2007). doi:10.1016/j.enpol.2006.12.001.
- 5) S. Sargunanathan, A. Elango, and S.T. Mohideen, "Performance enhancement of solar photovoltaic cells using effective cooling methods: a review," *Renew. Sustain. Energy Rev.*, 64 382–393 (2016). doi:10.1016/j.rser.2016.06.024.
- 6) A. Sharma, Deepak Kumar Raj, D. Kumar, A. Kumar, A. Kumar, and Mithilesh Kumar Sahu, "Design and development of novel solar concentrating spittoon to control the spread of covid-19 virus at public places," *Evergreen*, 10 (3) 1430–1438 (2023).

- doi:10.5109/7151692.
- 7) A. Sharma, "A comprehensive study of solar power in india and world," *Renew. Sustain. Energy Rev.*, 15 (4) 1767–1776 (2011). doi:10.1016/j.rser.2010.12.017.
  - 8) Louay A. Rasheed, Jamal A.-K. Mohammed, and Raed A. Jessam, "Performance enhancement of solar air heater by integrating innovative absorber design and automatic control flow rate," *Evergreen*, 10 (3) 1439–1448 (2023). doi:10.5109/7151693.
  - 9) S. Zaphar, M. Chandrashekara, and G. Verma, "Enhancing the thermal efficiency and optimum temperature of a modified evacuated tube solar air collector by using the reflector," *Evergreen*, 10 (4) 2265–2276 (2023). doi:10.5109/7160902.
  - 10) A. Shukla, K. Kant, A. Sharma, and P.H. Biwole, "Cooling methodologies of photovoltaic module for enhancing electrical efficiency: a review," *Sol. Energy Mater. Sol. Cells*, 160 (July 2016) 275–286 (2017). doi:10.1016/j.solmat.2016.10.047.
  - 11) Basam A. Shallal, E. Gedik, Hasanain A. Abdul Wahhab, and Mohammed G. Ajel, "Impact of alumina nanoparticles additives on open -flow flat collector performance for pv panel thermal control application," *Evergreen*, 10 (2) 870–879 (2023). doi:10.5109/6792842.
  - 12) M.W. AlShaar, Z. Al-Omari, W. Emar, M. Alnsour, and G. Abu-Rumman, "Application of pv-thermal array for pumping irrigation water as an alternative to pv in ghor al-safi, jordan: a case study," *Evergreen*, 9 (4) 1140–1150 (2022). doi:10.5109/6625725.
  - 13) M. Hosenuzzaman, N.A. Rahim, J. Selvaraj, M. Hasanuzzaman, A.B.M.A. Malek, and A. Nahar, "Global prospects, progress, policies, and environmental impact of solar photovoltaic power generation," *Renew. Sustain. Energy Rev.*, 41 284–297 (2015). doi:10.1016/j.rser.2014.08.046.
  - 14) S.K. Gupta, and S. Pradhan, "A review of recent advances and the role of nanofluid in solar photovoltaic thermal (pv/t) system," *Mater. Today Proc.*, 44 (xxxx) 782–791 (2021). doi:10.1016/j.matpr.2020.10.708.
  - 15) B. Agrawal, and G.N. Tiwari, "Optimizing the energy and exergy of building integrated photovoltaic thermal (bipvt) systems under cold climatic conditions," *Appl. Energy*, 87 (2) 417–426 (2010). doi:10.1016/j.apenergy.2009.06.011.
  - 16) S. Nižetić, A.M. Papadopoulos, and E. Giama, "Comprehensive analysis and general economic-environmental evaluation of cooling techniques for photovoltaic panels, part i: passive cooling techniques," *Energy Convers. Manag.*, 149 334–354 (2017). doi:10.1016/j.enconman.2017.07.022.
  - 17) H.M. Ali, "Recent advancements in pv cooling and efficiency enhancement integrating phase change materials based systems – a comprehensive review," *Sol. Energy*, 197 (June 2018) 163–198 (2020). doi:10.1016/j.solener.2019.11.075.
  - 18) A.W. Kandeal, A.K. Thakur, M.R. Elkadeem, M.F. Elmorshedy, Z. Ullah, R. Sathyamurthy, and S.W. Sharshir, "Photovoltaics performance improvement using different cooling methodologies: a state-of-art review," *J. Clean. Prod.*, 273 122772 (2020). doi:10.1016/j.jclepro.2020.122772.
  - 19) A. Maleki, A. Haghghi, M. El Haj Assad, I. Mahariq, and M. Alhuyi Nazari, "A review on the approaches employed for cooling pv cells," *Sol. Energy*, 209 (June 2020) 170–185 (2020). doi:10.1016/j.solener.2020.08.083.
  - 20) A. Nahar, M. Hasanuzzaman, and N.A. Rahim, "Numerical and experimental investigation on the performance of a photovoltaic thermal collector with parallel plate flow channel under different operating conditions in malaysia," *Sol. Energy*, 144 517–528 (2017). doi:10.1016/j.solener.2017.01.041.
  - 21) P. Dwivedi, S.A. Ganesh, K. Sudhakar, A. Soni, and S.S. Priya, "Thermal and electrical performance of uncooled, nature-cooled, and photovoltaic thermal module," *Int. J. Photoenergy*, 2023 1–12 (2023). doi:10.1155/2023/4720545.
  - 22) A.K. Hamzat, A.Z. Sahin, M.I. Omisanya, and L.M. Alhems, "Advances in pv and pvt cooling technologies: a review," *Sustain. Energy Technol. Assessments*, 47 (May) 101360 (2021). doi:10.1016/j.seta.2021.101360.
  - 23) M. Fuentes, M. Vivar, J. de la Casa, and J. Aguilera, "An experimental comparison between commercial hybrid pv-t and simple pv systems intended for bipv," *Renew. Sustain. Energy Rev.*, 93 (May) 110–120 (2018). doi:10.1016/j.rser.2018.05.021.
  - 24) T. Ma, Z. Li, and J. Zhao, "Photovoltaic panel integrated with phase change materials (pv-pcm): technology overview and materials selection," *Renew. Sustain. Energy Rev.*, 116 (July) 109406 (2019). doi:10.1016/j.rser.2019.109406.
  - 25) M.A. Kibria, R. Saidur, F.A. Al-Sulaiman, and M.M.A. Aziz, "Development of a thermal model for a hybrid photovoltaic module and phase change materials storage integrated in buildings," *Sol. Energy*, 124 114–123 (2016). doi:10.1016/j.solener.2015.11.027.
  - 26) S. Khanna, K.S. Reddy, and T.K. Mallick, "Performance analysis of tilted photovoltaic system integrated with phase change material under varying operating conditions," *Energy*, 133 887–899 (2017). doi:10.1016/j.energy.2017.05.150.
  - 27) A. Beniwal, C. Kumar, D.K. Sharma, and A. Jhalani, "Thermal regulation and performance improvement of solar pv panel using pcm om29," *Evergreen*, 10 (4) 2583–2589 (2023). doi:10.5109/7160913.

- 28) Y. Lin, Y. Jia, G. Alva, and G. Fang, "Review on thermal conductivity enhancement, thermal properties and applications of phase change materials in thermal energy storage," *Renew. Sustain. Energy Rev.*, 82 (September 2017) 2730–2742 (2018). doi:10.1016/j.rser.2017.10.002.
- 29) O. Krishan, and S. Suhag, "Techno-economic analysis of a hybrid renewable energy system for an energy poor rural community," *J. Energy Storage*, 23 (April) 305–319 (2019). doi:10.1016/j.est.2019.04.002.
- 30) M.A. Akrouch, K. Chahine, J. Faraj, F. Hachem, C. Castelain, and M. Khaled, "Advancements in cooling techniques for enhanced efficiency of solar photovoltaic panels: a detailed comprehensive review and innovative classification," *Energy Built Environ.*, (November) (2023). doi:10.1016/j.enbenv.2023.11.002.
- 31) P. Dwivedi, K. Sudhakar, A. Soni, E. Solomin, and I. Kirpichnikova, "Advanced cooling techniques of p.v. modules: a state of art," *Case Stud. Therm. Eng.*, 21 (December 2019) (2020). doi:10.1016/j.csite.2020.100674.
- 32) C. Zhang, C. Shen, Y. Zhang, C. Sun, D. Chwieduk, and S.A. Kalogirou, "Optimization of the electricity/heat production of a pv/t system based on spectral splitting with ag nanofluid," *Renew. Energy*, 180 30–39 (2021). doi:10.1016/j.renene.2021.08.020.
- 33) C.S. Solanki, "Solar photovoltaic technology and systems: a manual for technicians, trainers and engineers," PHI Learning Private Limited, Delhi, Delhi, India, 2021.
- 34) E. Skoplaki, and J.A. Palyvos, "On the temperature dependence of photovoltaic module electrical performance: a review of efficiency/power correlations," *Sol. Energy*, 83 (5) 614–624 (2009). doi:10.1016/j.solener.2008.10.008.
- 35) M. Abdolzadeh, and M. Ameri, "Improving the effectiveness of a photovoltaic water pumping system by spraying water over the front of photovoltaic cells," *Renew. Energy*, 34 (1) 91–96 (2009). doi:10.1016/j.renene.2008.03.024.
- 36) S. Nižetić, D. Čoko, A. Yadav, and F. Grubišić-Čabo, "Water spray cooling technique applied on a photovoltaic panel: the performance response," *Energy Convers. Manag.*, 108 287–296 (2016). doi:10.1016/j.enconman.2015.10.079.
- 37) İ. Erdoğan, K. Bilen, and S. Kivrak, "Experimental investigation of the efficiency of solar panel over which water film flows," *Politek. Derg.*, 27 (2) 699–707 (2024). doi:10.2339/politeknik.1163785.
- 38) A.S. Kaiser, B. Zamora, R. Mazón, J.R. García, and F. Vera, "Experimental study of cooling bipv modules by forced convection in the air channel," *Appl. Energy*, 135 88–97 (2014). doi:10.1016/j.apenergy.2014.08.079.
- 39) N.A.S. Elminshawy, A.M.I. Mohamed, K. Morad, Y. Elhenawy, and A.A. Alrobaian, "Performance of pv panel coupled with geothermal air cooling system subjected to hot climatic," *Appl. Therm. Eng.*, 148 (November 2017) 1–9 (2019). doi:10.1016/j.applthermaleng.2018.11.027.
- 40) A. Hussien, A. Eltayesh, and H.M. El-Batsh, "Experimental and numerical investigation for pv cooling by forced convection," *Alexandria Eng. J.*, 64 427–440 (2023). doi:10.1016/j.aej.2022.09.006.
- 41) G. Li, S. Shittu, K. Zhou, X. Zhao, and X. Ma, "Preliminary experiment on a novel photovoltaic-thermoelectric system in summer," *Energy*, 188 116041 (2019). doi:10.1016/j.energy.2019.116041.
- 42) A. Khanalizadeh, F. Razi Astaraci, M.M. Heyhat, and M.A. Vaziri Rad, "Experimental investigation of a pv/t system containing a teg section between water-based heat exchanger and air-based heat sink," *Therm. Sci. Eng. Prog.*, 42 (December 2022) 101909 (2023). doi:10.1016/j.tsep.2023.101909.
- 43) D. Enescu, and F. Spertino, "Applications of hybrid photovoltaic modules with thermoelectric cooling," *Energy Procedia*, 111 (September 2016) 904–913 (2017). doi:10.1016/j.egypro.2017.03.253.
- 44) M. Chandrasekar, S. Suresh, T. Senthilkumar, and M. Ganesh, "Passive cooling of standalone flat pv module with cotton wick structures," *Energy Convers. Manag.*, 71 43–50 (2013). doi:10.1016/j.enconman.2013.03.012.
- 45) M.R. Salem, R.K. Ali, and K.M. Elshazly, "Experimental investigation of the performance of a hybrid photovoltaic/thermal solar system using aluminium cooling plate with straight and helical channels," *Sol. Energy*, 157 147–156 (2017). doi:10.1016/j.solener.2017.08.019.
- 46) M. Alktrane, Q. Al-Yasiri, M.A. Shehab, P. Bencs, Z. Németh, and K. Hernadi, "Experimental and numerical study of a photovoltaic/thermal system cooled by metal oxide nanofluids," *Alexandria Eng. J.*, 94 (October 2023) 55–67 (2024). doi:10.1016/j.aej.2024.03.050.
- 47) Z. Zou, W. Yan, H. Gong, Y. Wang, and J. Shao, "Quantifying the performance advantage of the novel passive air cooling system for pv array and system structure optimization," *Appl. Therm. Eng.*, 149 (December 2018) 899–908 (2019). doi:10.1016/j.applthermaleng.2018.12.085.
- 48) K. Mankani, H. Nasarullah Chaudhry, and J. Kaiser Calautit, "Optimization of an air-cooled heat sink for cooling of a solar photovoltaic panel: a computational study," *Energy Build.*, 270 112274 (2022). doi:10.1016/j.enbuild.2022.112274.
- 49) F. Grubišić Čabo, S. Nižetić, E. Giama, and A. Papadopoulos, "Techno-economic and

- environmental evaluation of passive cooled photovoltaic systems in mediterranean climate conditions,” *Appl. Therm. Eng.*, 169 (January) (2020). doi:10.1016/j.applthermaleng.2020.114947.
- 50) C.L. Pinto, I. Cornago, and J. Bengoechea, “Outdoor thermal performance of photovoltaic devices with enhanced daytime radiative cooling glass,” *Energy Technol.*, 11 (7) 1–11 (2023). doi:10.1002/ente.202300069.
  - 51) K. Wang, G. Luo, X. Guo, S. Li, Z. Liu, and C. Yang, “Radiative cooling of commercial silicon solar cells using a pyramid-textured pdms film,” *Sol. Energy*, 225 (November 2020) 245–251 (2021). doi:10.1016/j.solener.2021.07.025.
  - 52) A.A.B. Baloch, H.M.S. Bahaidarah, P. Gandhidasan, and F.A. Al-Sulaiman, “Experimental and numerical performance analysis of a converging channel heat exchanger for pv cooling,” *Energy Convers. Manag.*, 103 14–27 (2015). doi:10.1016/j.enconman.2015.06.018.
  - 53) H. Bahaidarah, A. Subhan, P. Gandhidasan, and S. Rehman, “Performance evaluation of a pv (photovoltaic) module by back surface water cooling for hot climatic conditions,” *Energy*, 59 445–453 (2013). doi:10.1016/j.energy.2013.07.050.
  - 54) R. Mazón-Hernández, J.R. García-Cascales, F. Vera-García, A.S. Káiser, and B. Zamora, “Improving the electrical parameters of a photovoltaic panel by means of an induced or forced air stream,” *Int. J. Photoenergy*, 2013 1–10 (2013). doi:10.1155/2013/830968.
  - 55) T. Nabil, and T.M. Mansour, “Augmenting the performance of photovoltaic panel by decreasing its temperature using various cooling techniques,” *Results Eng.*, 15 (August) 100564 (2022). doi:10.1016/j.rineng.2022.100564.
  - 56) M. Emam, A.M.A. Soliman, M.A. Abdelrahman, and A.A.A. Attia, “Performance improvement of single-junction photovoltaic systems using a new design of a heat pipe-based heat sink: experimental study,” *Appl. Therm. Eng.*, 219 (December 2021) 119653 (2023). doi:10.1016/j.applthermaleng.2022.119653.
  - 57) M. Kargaran, H.R. Goshayeshi, and A.R.A. Jajarm, “A novel integrated photovoltaic system with a three-dimensional pulsating heat pipe,” *Front. Heat Mass Transf.*, 22 (5) 1461–1476 (2024). doi:10.32604/fhmt.2024.056284.
  - 58) T. Wongwuttanasatian, T. Sarikarin, and A. Suksri, “Performance enhancement of a photovoltaic module by passive cooling using phase change material in a fi nned container heat sink,” *Sol. Energy*, 195 (October 2019) 47–53 (2020). doi:10.1016/j.solener.2019.11.053.
  - 59) R. M., L. S., R. S., A. H., and D. A., “Experimental investigation on the abasement of operating temperature in solar photovoltaic panel using pcm and aluminium,” *Sol. Energy*, 188 (February) 327–338 (2019). doi:10.1016/j.solener.2019.05.067.
  - 60) Z. Li, T. Ma, J. Zhao, A. Song, and Y. Cheng, “Experimental study and performance analysis on solar photovoltaic panel integrated with phase change material,” *Energy*, 178 471–486 (2019). doi:10.1016/j.energy.2019.04.166.
  - 61) A.A. Alshammari, E.M. Salilih, E. Almatrafi, and M. Rady, “Polymeric coatings for passive radiative cooling of pv modules in hot and humid weather: design, optimization, and performance evaluation,” *Case Stud. Therm. Eng.*, 57 (April) 1–15 (2024). doi:10.1016/j.csite.2024.104341.
  - 62) K.Y. Leong, M. Rosdzimin, A. Rahman, and B.A. Gurunathan, “Nano-enhanced phase change materials : a review of thermo-physical properties , applications and challenges,” *J. Energy Storage*, 21 (July 2018) 18–31 (2019). doi:10.1016/j.est.2018.11.008.
  - 63) R. Reji Kumar, M. Samykan, A.K. Pandey, K. Kadirgama, and V. V. Tyagi, “Phase change materials and nano-enhanced phase change materials for thermal energy storage in photovoltaic thermal systems: a futuristic approach and its technical challenges,” *Renew. Sustain. Energy Rev.*, 133 (July) 110341 (2020). doi:10.1016/j.rser.2020.110341.
  - 64) L. Yang, J. nan Huang, and F. Zhou, “Thermophysical properties and applications of nano-enhanced pcms: an update review,” *Energy Convers. Manag.*, 214 (April) 112876 (2020). doi:10.1016/j.enconman.2020.112876.
  - 65) K. Velmurugan, S. Kumarasamy, T. Wongwuttanasatian, and V. Seithtanabutara, “Review of pcm types and suggestions for an applicable cascaded pcm for passive pv module cooling under tropical climate conditions,” *J. Clean. Prod.*, 293 126065 (2021). doi:10.1016/j.jclepro.2021.126065.
  - 66) J. Wang, H. Xie, Z. Guo, L. Guan, and Y. Li, “Improved thermal properties of paraffin wax by the addition of tio2 nanoparticles,” *Appl. Therm. Eng.*, 73 (2) 1541–1547 (2014). doi:10.1016/j.applthermaleng.2014.05.078.
  - 67) C. Li, B. Zhang, B. Xie, X. Zhao, J. Chen, Z. Chen, and Y. Long, “Stearic acid/expanded graphite as a composite phase change thermal energy storage material for tankless solar water heater,” *Sustain. Cities Soc.*, 44 (October 2018) 458–464 (2019). doi:10.1016/j.scs.2018.10.041.
  - 68) K.R. Suresh Kumar, and S. Kalaiselvam, “Experimental investigations on the thermophysical properties of cuo-palmitic acid phase change material for heating applications,” *J. Therm. Anal. Calorim.*, 129 (3) 1647–1657 (2017). doi:10.1007/s10973-017-

- 6301-9.
- 69) A. Vasu, F.Y. Hagos, R. Mamat, J. Kaur, and M.M. Noor, "The effect of thermal cyclic variation on the thermophysical property degradation of paraffin as a phase changing energy storage material," *Appl. Therm. Eng.*, 149 (September 2018) 22–33 (2019). doi:10.1016/j.applthermaleng.2018.12.033.
  - 70) E.H. Amalu, and O.A. Fabunmi, "Thermal control of crystalline silicon photovoltaic (c-si pv) module using docosane phase change material (pcm) for improved performance," *Sol. Energy*, 234 (February) 203–221 (2022). doi:10.1016/j.solener.2022.02.001.
  - 71) Akshayveer, A. Kumar, A. Pratap Singh, R. Sreeram Kotha, and O.P. Singh, "Thermal energy storage design of a new bifacial pv/pcm system for enhanced thermo-electric performance," *Energy Convers. Manag.*, 250 (October) 114912 (2021). doi:10.1016/j.enconman.2021.114912.
  - 72) Z. Fu, Y. Li, X. Liang, S. Lou, Z. Qiu, Z. Cheng, and Q. Zhu, "Experimental investigation on the enhanced performance of a solar pvt system using micro-encapsulated pcms," *Energy*, 228 120509 (2021). doi:10.1016/j.energy.2021.120509.
  - 73) N. Choubineh, H. Jannesari, and A. Kasaeian, "Experimental study of the effect of using phase change materials on the performance of an air-cooled photovoltaic system," *Renew. Sustain. Energy Rev.*, 101 (November 2018) 103–111 (2019). doi:10.1016/j.rser.2018.11.001.
  - 74) Akshayveer, A.P. Singh, A. Kumar, and O.P. Singh, "Effect of natural convection and thermal storage system on the electrical and thermal performance of a hybrid pv-t/pcm systems," *Mater. Today Proc.*, 39 (xxxx) 1899–1904 (2019). doi:10.1016/j.matpr.2020.08.010.
  - 75) P. Singh, V. Mudgal, S. Khanna, T.K. Mallick, and K.S. Reddy, "Experimental investigation of solar photovoltaic panel integrated with phase change material and multiple conductivity-enhancing-containers," *Energy*, 205 118047 (2020). doi:10.1016/j.energy.2020.118047.
  - 76) H.M. Taqi Al-Najjar, and J.M. Mahdi, "Novel mathematical modeling, performance analysis, and design charts for the typical hybrid photovoltaic/phase-change material (pv/pcm) system," *Appl. Energy*, 315 (February) 119027 (2022). doi:10.1016/j.apenergy.2022.119027.
  - 77) P.H. Biwole, P. Eclache, and F. Kuznik, "Phase-change materials to improve solar panel's performance," *Energy Build.*, 62 59–67 (2013). doi:10.1016/j.enbuild.2013.02.059.
  - 78) S. Khanna, K.S. Reddy, and T.K. Mallick, "Optimization of finned solar photovoltaic phase change material (finned pv pcm) system," *Int. J. Therm. Sci.*, 130 (March) 313–322 (2018). doi:10.1016/j.ijthermalsci.2018.04.033.
  - 79) M.B. Elsheniti, M.A. Hemedah, M.M. Sorour, and W.M. El-Maghlany, "Novel enhanced conduction model for predicting performance of a pv panel cooled by pcm," *Energy Convers. Manag.*, 205 (December 2019) 112456 (2020). doi:10.1016/j.enconman.2019.112456.
  - 80) A.S. Abdelrazik, F.A. Al-Sulaiman, and R. Saidur, "Numerical investigation of the effects of the nano-enhanced phase change materials on the thermal and electrical performance of hybrid pv/thermal systems," *Energy Convers. Manag.*, 205 (August 2019) 112449 (2020). doi:10.1016/j.enconman.2019.112449.
  - 81) S. Sharma, L. Micheli, W. Chang, A.A. Tahir, K.S. Reddy, and T.K. Mallick, "Nano-enhanced phase change material for thermal management of bicpv," *Appl. Energy*, 208 (May 2017) 719–733 (2017). doi:10.1016/j.apenergy.2017.09.076.
  - 82) A. Hasan, S.J. McCormack, M.J. Huang, and B. Norton, "Energy and cost saving of a photovoltaic-phase change materials (pv-pcm) system through temperature regulation and performance enhancement of photovoltaics," *Energies*, 7 (3) 1318–1331 (2014). doi:10.3390/en7031318.
  - 83) D. Su, Y. Jia, G. Alva, L. Liu, and G. Fang, "Comparative analyses on dynamic performances of photovoltaic–thermal solar collectors integrated with phase change materials," *Energy Convers. Manag.*, 131 79–89 (2017). doi:10.1016/j.enconman.2016.11.002.
  - 84) M.C. Browne, B. Norton, and S.J. McCormack, "Heat retention of a photovoltaic/thermal collector with pcm," *Sol. Energy*, 133 533–548 (2016). doi:10.1016/j.solener.2016.04.024.
  - 85) M.J. Huang, P.C. Eames, B. Norton, and N.J. Hewitt, "Natural convection in an internally finned phase change material heat sink for the thermal management of photovoltaics," *Sol. Energy Mater. Sol. Cells*, 95 (7) 1598–1603 (2011). doi:10.1016/j.solmat.2011.01.008.
  - 86) T. Maatallah, R. Zachariah, and F.G. Al-Amri, "Exergo-economic analysis of a serpentine flow type water based photovoltaic thermal system with phase change material (pvt-pcm/water)," *Sol. Energy*, 193 (July) 195–204 (2019). doi:10.1016/j.solener.2019.09.063.
  - 87) T. Ma, J. Zhao, and Z. Li, "Mathematical modelling and sensitivity analysis of solar photovoltaic panel integrated with phase change material," *Appl. Energy*, 228 (May) 1147–1158 (2018). doi:10.1016/j.apenergy.2018.06.145.
  - 88) C.S. Malvi, D.W. Dixon-Hardy, and R. Crook, "Energy balance model of combined photovoltaic solar-thermal system incorporating phase change material," *Sol. Energy*, 85 (7) 1440–1446 (2011).

- doi:10.1016/j.solener.2011.03.027.
- 89) X. Yang, L. Sun, Y. Yuan, X. Zhao, and X. Cao, "Experimental investigation on performance comparison of pv/t-pcm system and pv/t system," *Renew. Energy*, 119 152–159 (2018). doi:10.1016/j.renene.2017.11.094.
  - 90) C.J. Smith, P.M. Forster, and R. Crook, "Global analysis of photovoltaic energy output enhanced by phase change material cooling," *Appl. Energy*, 126 21–28 (2014). doi:10.1016/j.apenergy.2014.03.083.
  - 91) M. Noura, and H. Sammouda, "Numerical study of an inclined photovoltaic system coupled with phase change material under various operating conditions," *Appl. Therm. Eng.*, 141 (November 2017) 958–975 (2018). doi:10.1016/j.applthermaleng.2018.06.039.
  - 92) R. Stropnik, and U. Stritih, "Increasing the efficiency of pv panel with the use of pcm," *Renew. Energy*, 97 671–679 (2016). doi:10.1016/j.renene.2016.06.011.
  - 93) S. Nižetić, M. Arıcı, F. Bilgin, and F. Grubišić-Čabo, "Investigation of pork fat as potential novel phase change material for passive cooling applications in photovoltaics," *J. Clean. Prod.*, 170 1006–1016 (2018). doi:10.1016/j.jclepro.2017.09.164.
  - 94) P. Motiei, M. Yaghoubi, and E. GoshtasbiRad, "Transient simulation of a hybrid photovoltaic-thermoelectric system using a phase change material," *Sustain. Energy Technol. Assessments*, 34 (May) 200–213 (2019). doi:10.1016/j.seta.2019.05.004.
  - 95) Y. Zhang, and X. Zhang, "Thermal properties of a new type of calcium chloride hexahydrate-magnesium chloride hexahydrate/expanded graphite composite phase change material and its application in photovoltaic heat dissipation," *Sol. Energy*, 204 (April) 683–695 (2020). doi:10.1016/j.solener.2020.05.037.
  - 96) S.R. Mousavi Baygi, and S.M. Sadrameli, "Thermal management of photovoltaic solar cells using polyethylene glycol1000 (peg1000) as a phase change material," *Therm. Sci. Eng. Prog.*, 5 (January) 405–411 (2018). doi:10.1016/j.tsep.2018.01.012.
  - 97) M. Sardarabadi, M. Passandideh-Fard, M.J. Maghrebi, and M. Ghazikhani, "Experimental study of using both znO/ water nanofluid and phase change material (pcm) in photovoltaic thermal systems," *Sol. Energy Mater. Sol. Cells*, 161 (November 2016) 62–69 (2017). doi:10.1016/j.solmat.2016.11.032.
  - 98) A. Hasan, J. Sarwar, H. Alnoman, and S. Abdelbaqi, "Yearly energy performance of a photovoltaic-phase change material (pv-pcm) system in hot climate," *Sol. Energy*, 146 417–429 (2017). doi:10.1016/j.solener.2017.01.070.
  - 99) M.S. Hossain, A.K. Pandey, J. Selvaraj, N.A. Rahim, M.M. Islam, and V. V. Tyagi, "Two side serpentine flow based photovoltaic-thermal-phase change materials (pvt-pcm) system: energy, exergy and economic analysis," *Renew. Energy*, 136 1320–1336 (2019). doi:10.1016/j.renene.2018.10.097.
  - 100) A.H.A. Al-Waeli, H.A. Kazem, M.T. Chaichan, and K. Sopian, "Experimental investigation of using nano-pcm/nanofluid on a photovoltaic thermal system (pvt): technical and economic study," *Therm. Sci. Eng. Prog.*, 11 (March) 213–230 (2019). doi:10.1016/j.tsep.2019.04.002.
  - 101) A. Durez, M. Ali, A. Waqas, K. Nazir, and S. Kumarasamy, "Modelling and optimization of phase change materials (pcm)-based passive cooling of solar pv panels in multi climate conditions," *Front. Energy Res.*, 11 (June) 1–11 (2023). doi:10.3389/fenrg.2023.1121138.