

Activity Report of Asia-Pacific Medical Network Project in Kyushu University Hospital : Vol.3

Shimizu, Shuji
Kyushu University Hospital

Nakashima, Naoki
Kyushu University Hospital

<https://doi.org/10.15017/8304>

出版情報 : 「超高速ネットワークを利用したアジア遠隔医療プロジェクト」 TEMDEC活動報告. 3, pp.1-144, 2007-04. AQUA事務局

バージョン :

権利関係 :

2) Configuration maps

#59 The 4th Pancreatobiliary Clinico-pathological Teleconference 2006.4.6

#59 2006.4.6

System Configuration of Teleconference(2006.4.6)

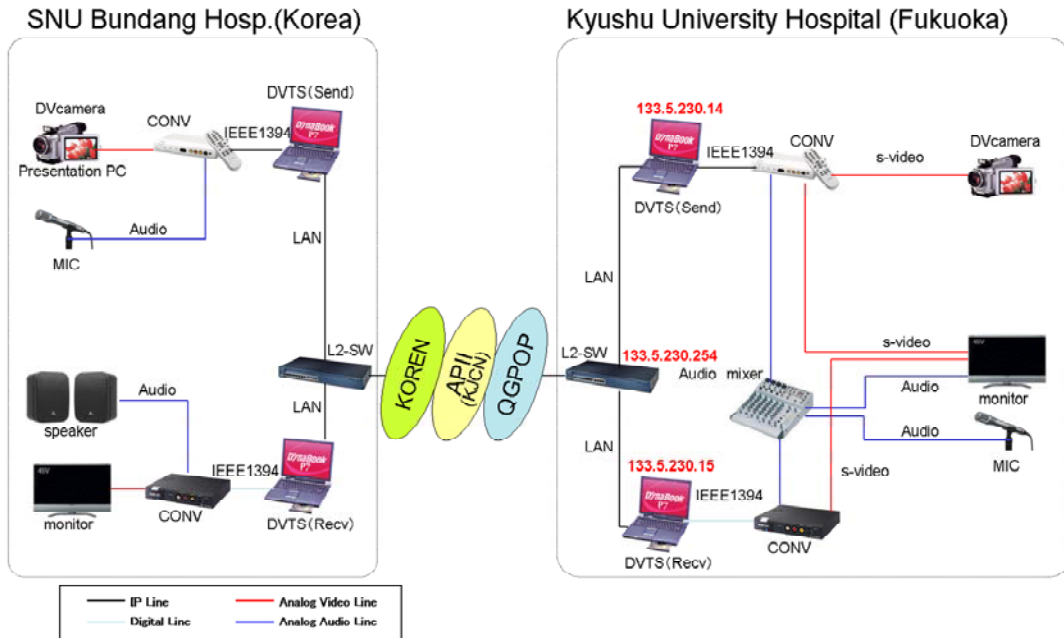

#60 The 94th Annual Meeting of the Japanese Urological Association 2006.4.13

#60 2006.4.13

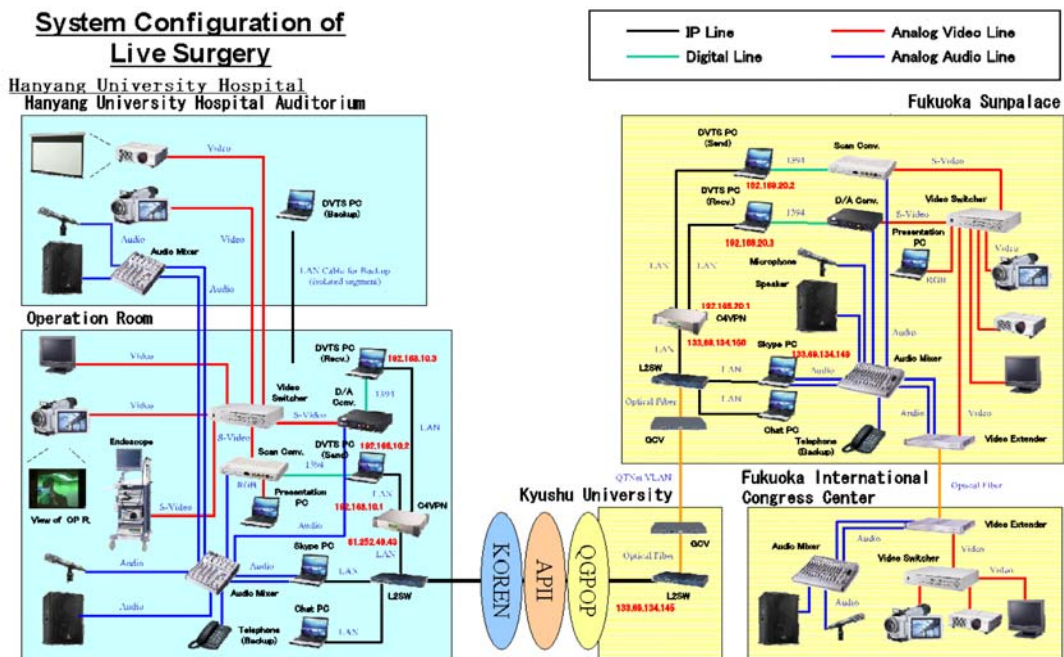

#61 Teleconference in Siriraj-Ramathibodi Medical Congress 2006.4.19

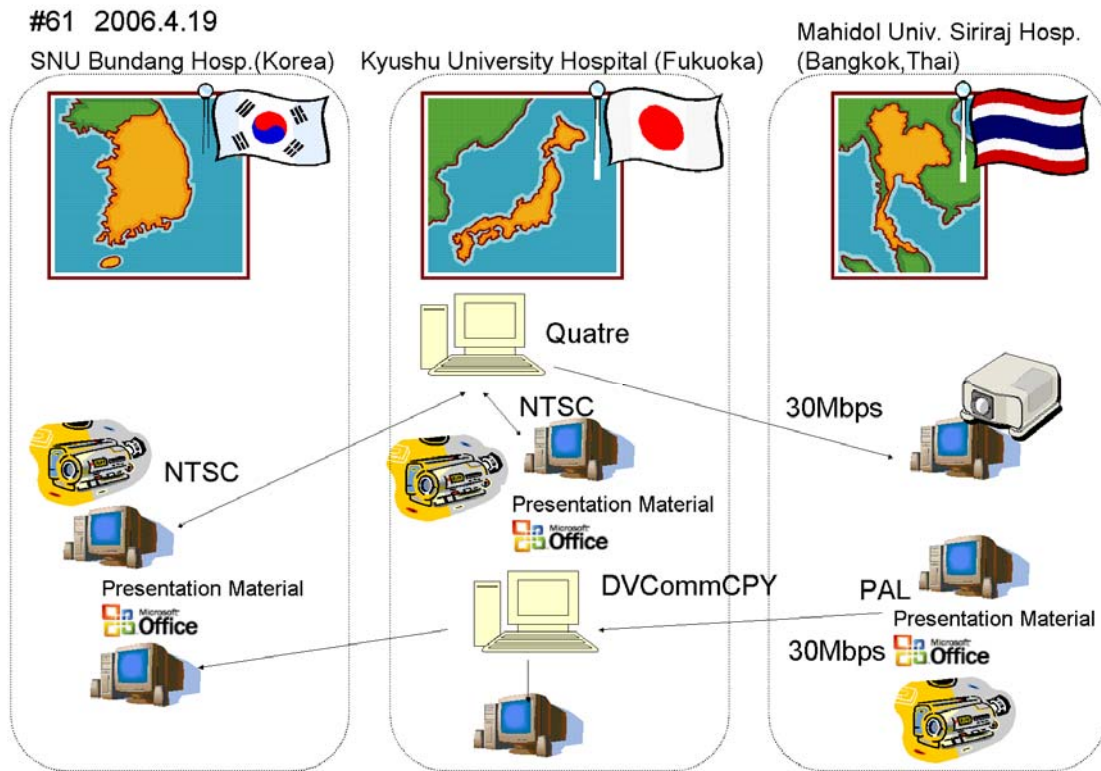

#62 The 1st P&P Committee Annual Meeting in 2006 2006.5.2

#62 2006.5.2

System Configuration of Teleconference(2006.5.2)

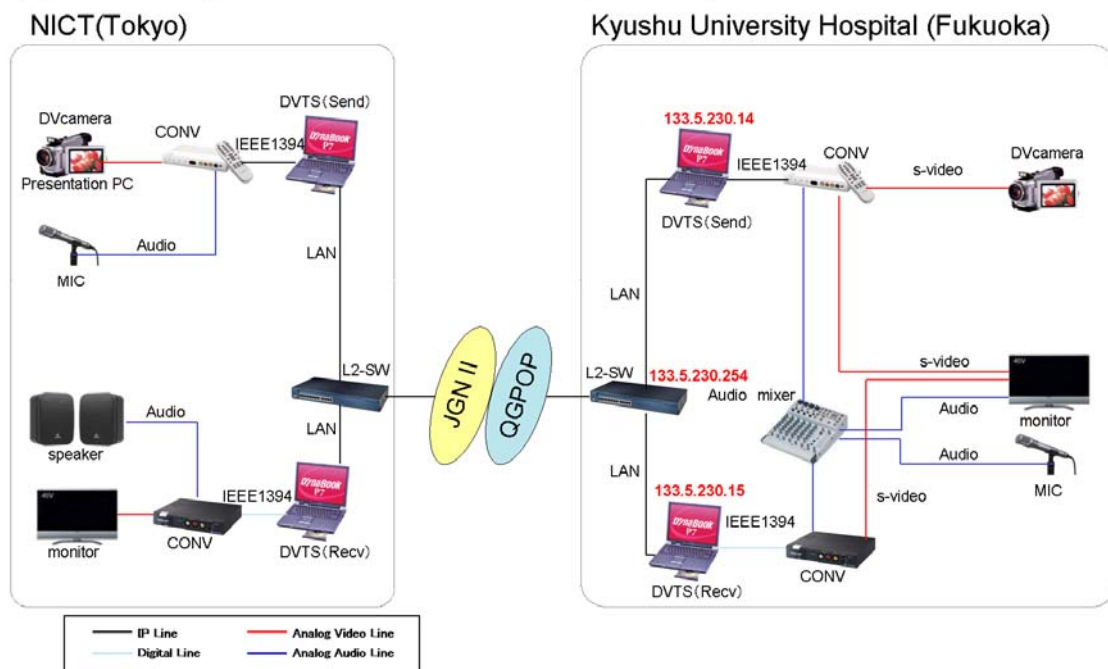

#63 The 1st Meeting on Telemedical collaboration between Taiwan and Japan
2006.5.9

#63 2006.5.9

System Configuration of Teleconference(2006.5.9)

National Taiwan University (Taiwan)

Kyushu University Hospital (Fukuoka)

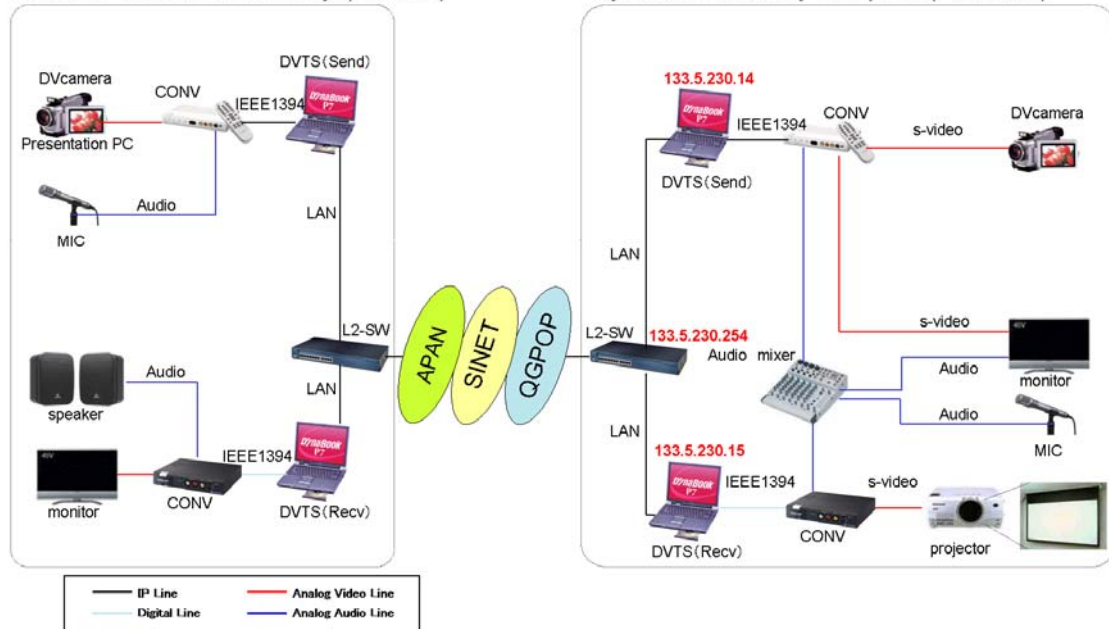

#64 Medical Live Demonstration on ASEM ICT Senior Official Meeting 2006.6.8

#64 2006.6.8

System Configuration of Teleconference(2006.6.8)

Halong Venue (Vietnam)

Kyushu University Hospital (Fukuoka)

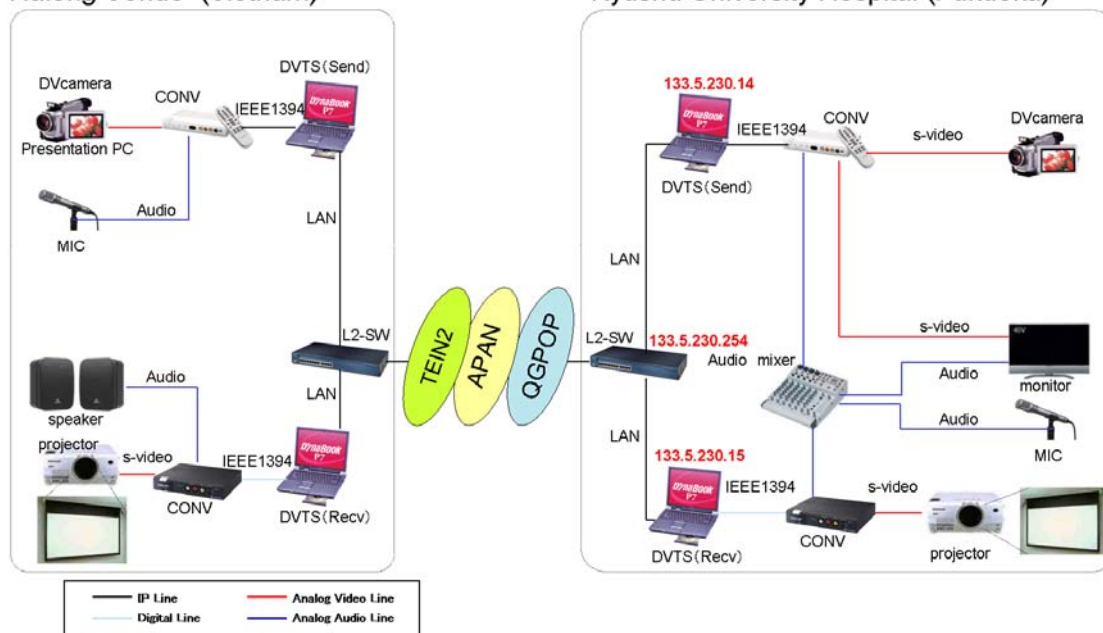

#65 Medical Live Demonstration on TEIN2 Meeting 2006.6.20

#65 2006.6.20

System Configuration of Teleconference(2006.6.20)

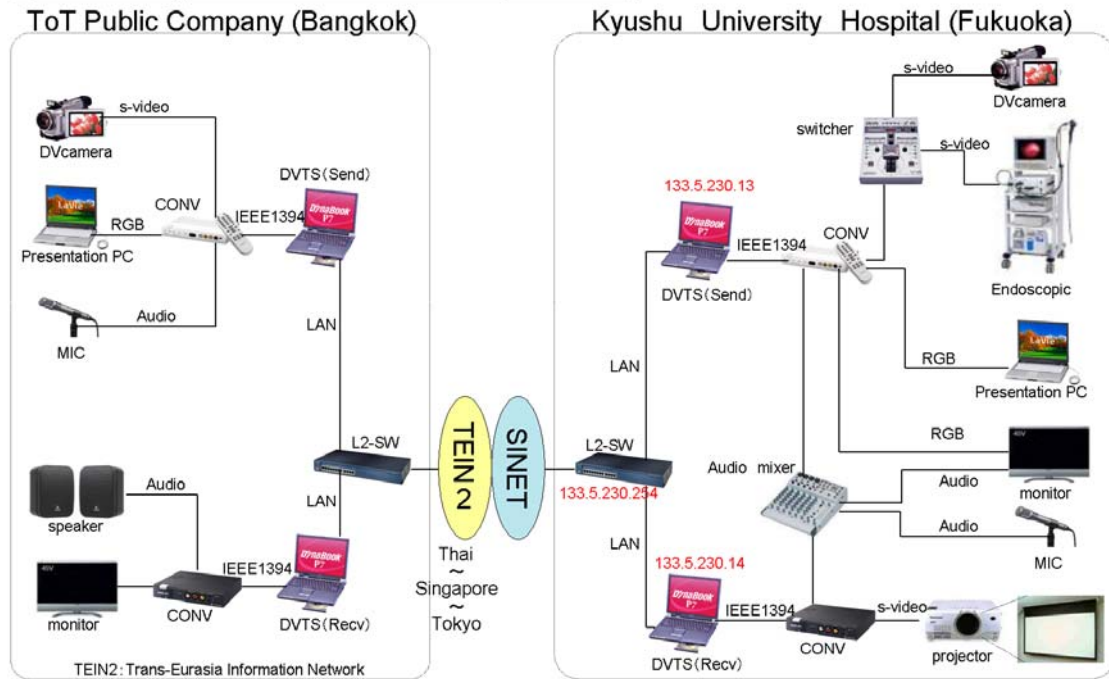

#66 Remote Presentation between Kyushu and Hanyang 2006.6.21

#66 2006.6.21

System Configuration of Teleconference(2006.6.21)

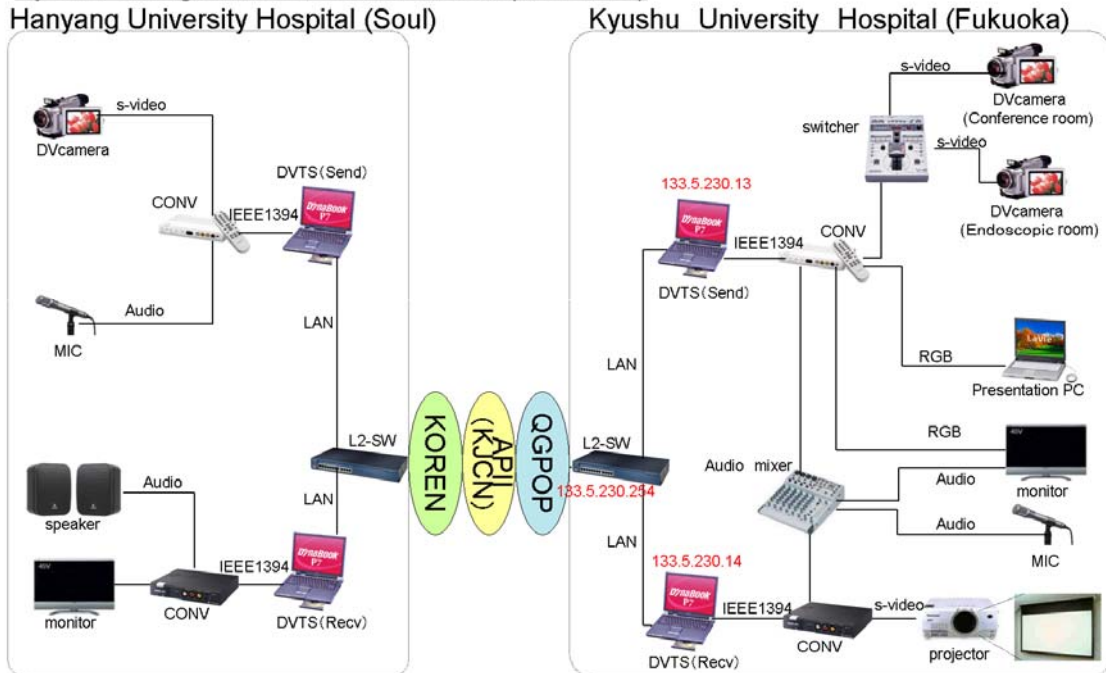

#67 APAN Meeting in Singapore - Activity Report 2006.7.20

#67 2006.7.20

Configuration of teleconference: 7/20 11:00~12:30

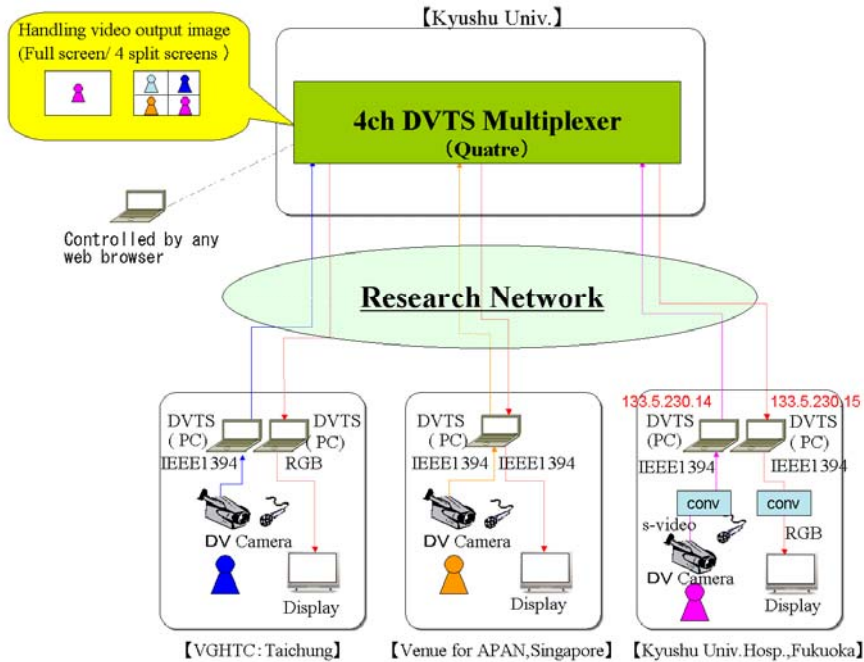

#68 APAN Meeting in Singapore - Medical Live Demonstration I 2006.7.20

#68 2006.7.20

Configuration of Live surgery(demo1): 7/20 14:00~15:30

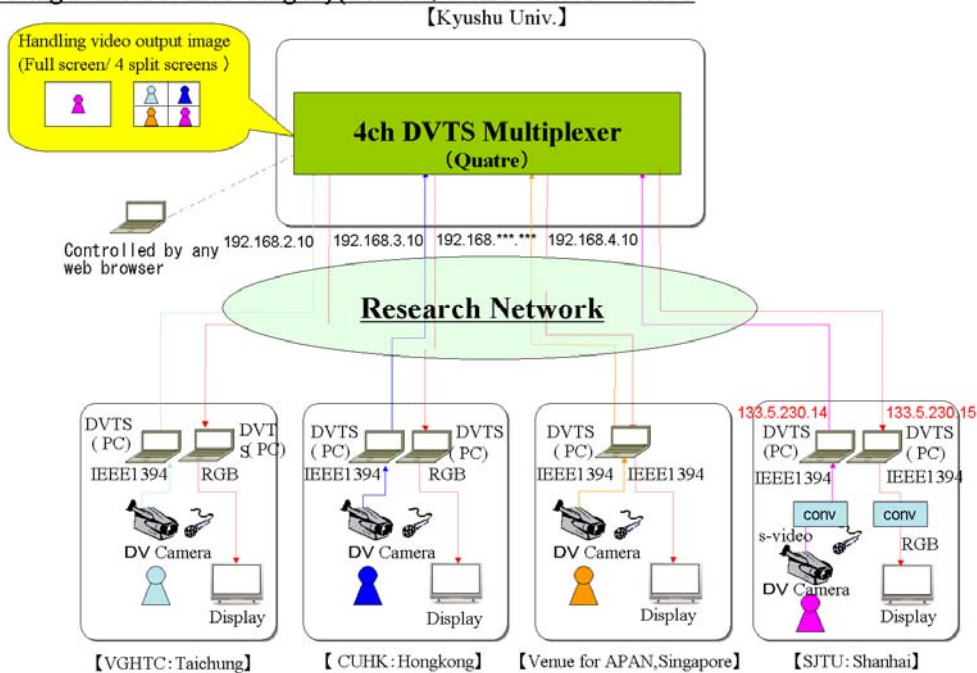

#69 APAN Meeting in Singapore - Medical Live Demonstration II 2006.7.20

#69 2006.7.20

Configuration of teleconference(demo2):7/20 16:00~17:30

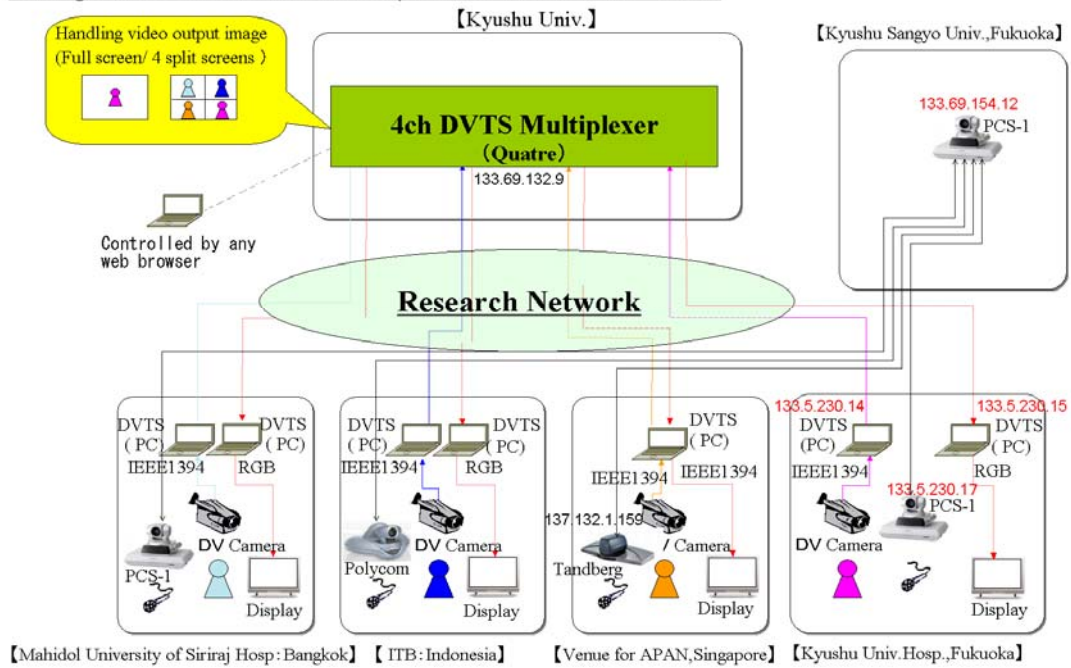

#70 The 1st Kyushu ESD Live Demonstration 2006.8.21

#70 2006.8.21

Configuration of Live surgery

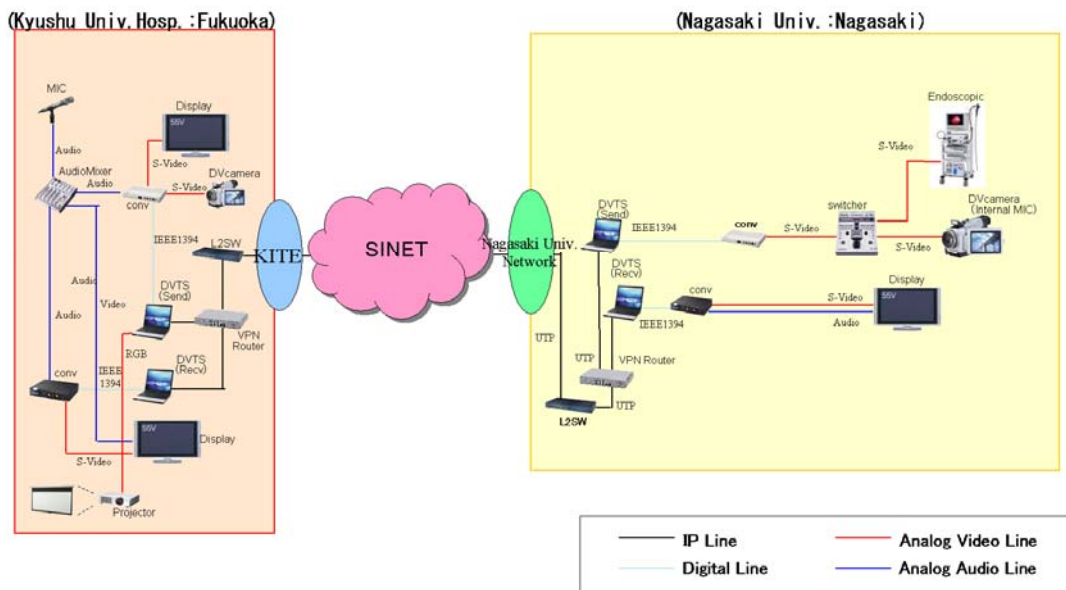

#71 AARNet3 Launch Ceremony 2006.9.14

#71 2006.9.14

Configuration of Live surgery

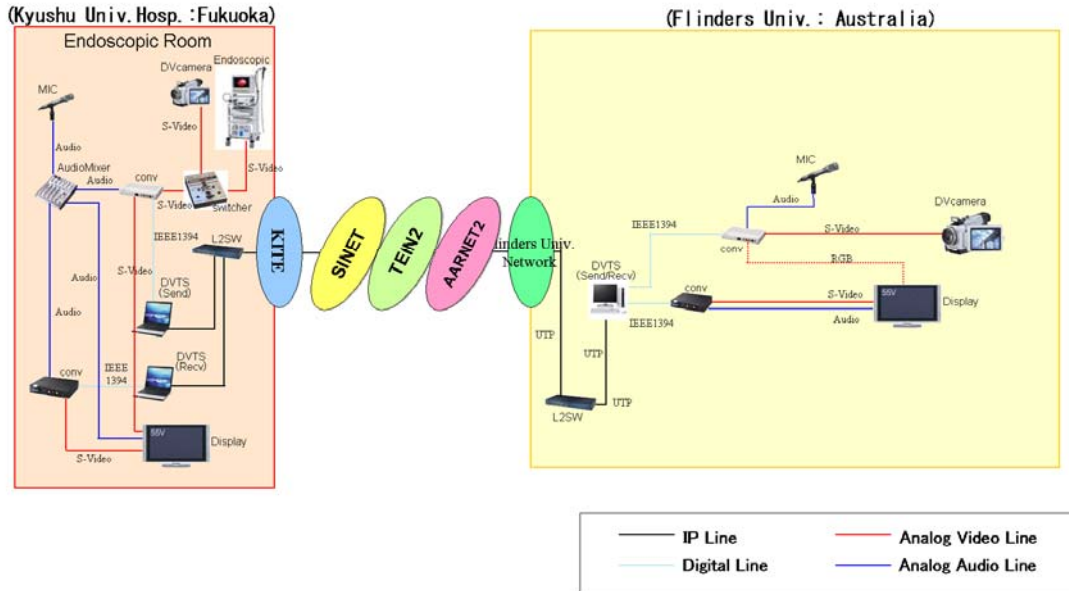

#72 The 1st Conference with Gyeongsang National University 2006.9.15

#72 2006.9.15

System Configuration of Teleconference(2006.9.15)

Gyeongsang National University (Korea)

Kyushu University Hospital (Fukuoka)

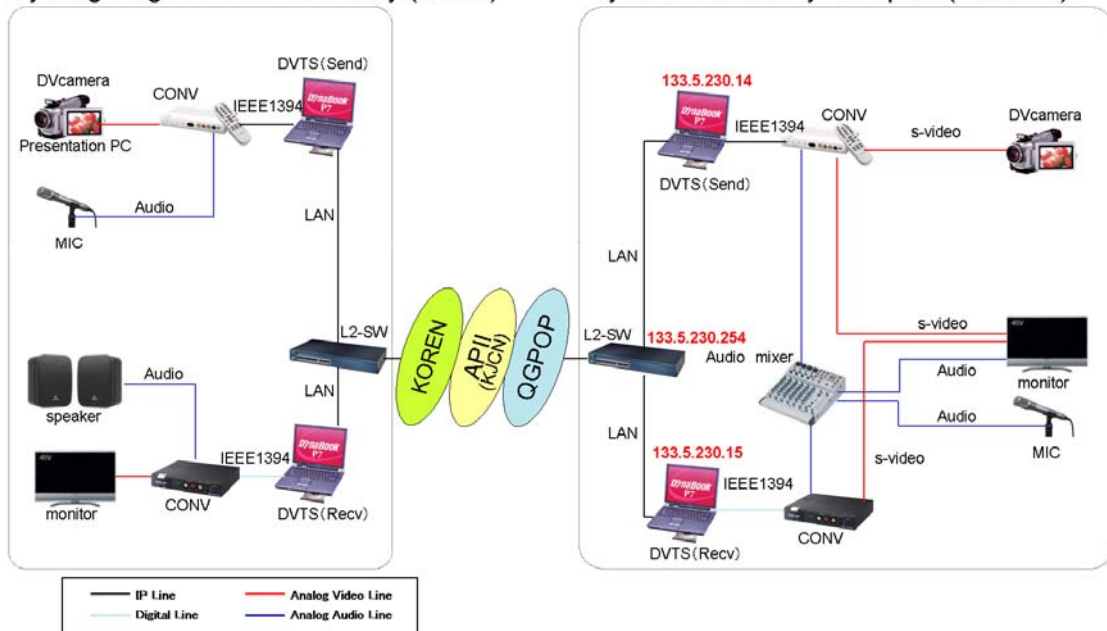

#73 The 1st Conference with Seoul National University Hospital 2006.9.22

System Configuration of Teleconference(2006.9.22)

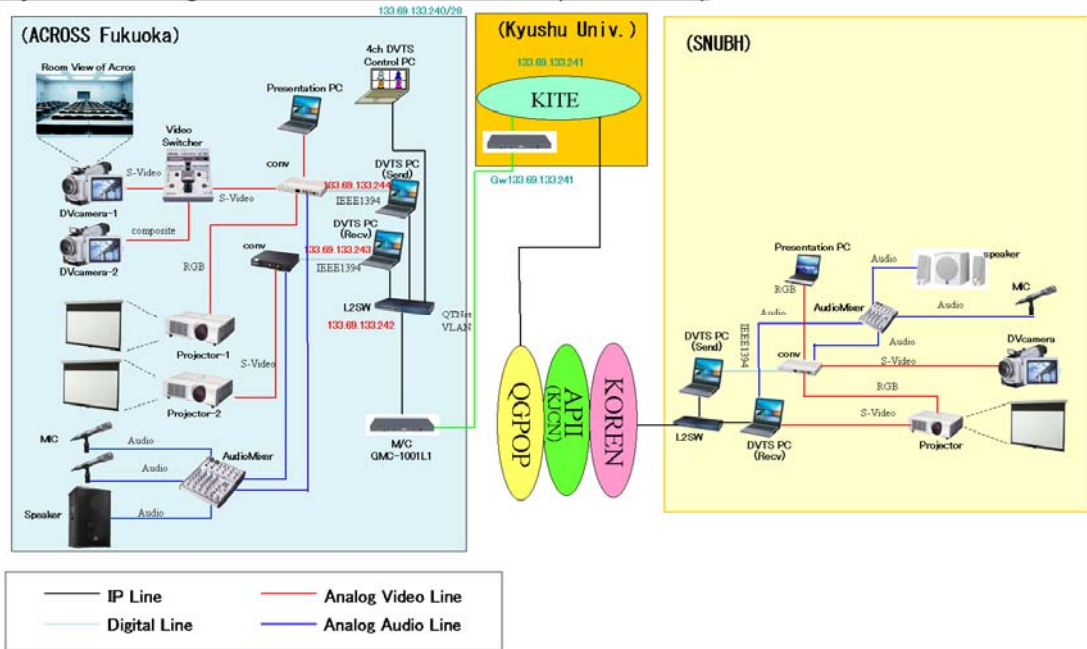

#74 The 6th Fukuoka Endoscopic Surgery Forum 2006.9.22

System Configuration of Teleconference(2006.9.22)

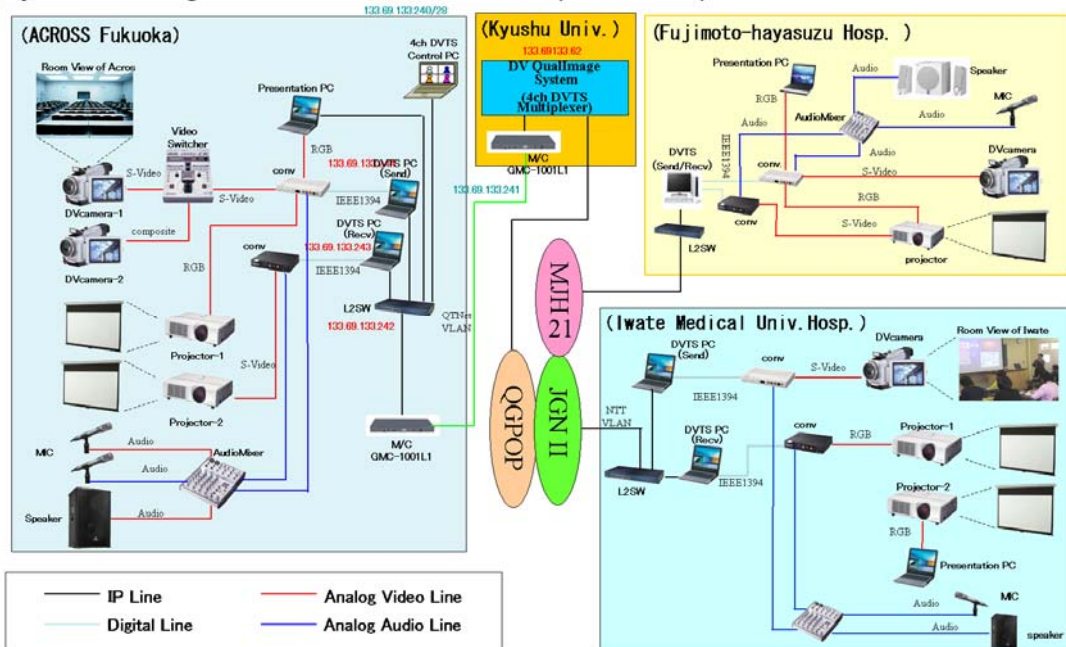

#75 The 5th Pancreatobiliary Clinico-pathological Teleconference 2006.9.28

#75 2006.9.28

System Configuration of Teleconference(2006.9.28)

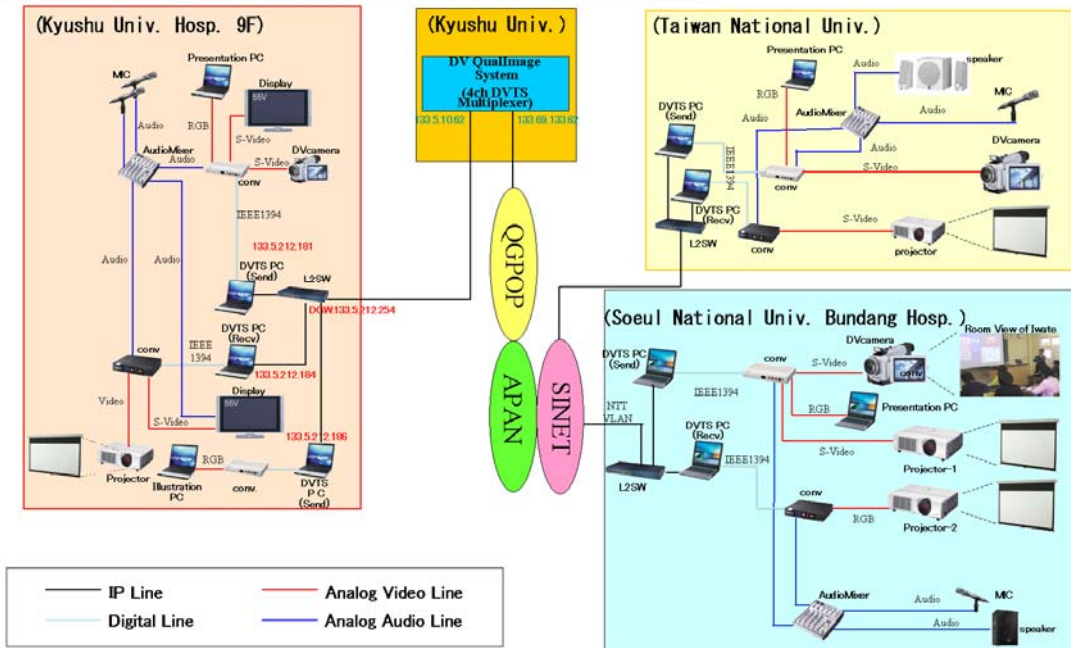

#76 The 1st JSPS Hematology Seminar in Fukuoka 2006.10.5

#76 2006.10.5

System Configuration of Teleconference (2006.10.5)

Mahidol Univ. Siriraj Hosp. (Bangkok, Thai)

Kyushu Univ. Hosp. (Fukuoka)

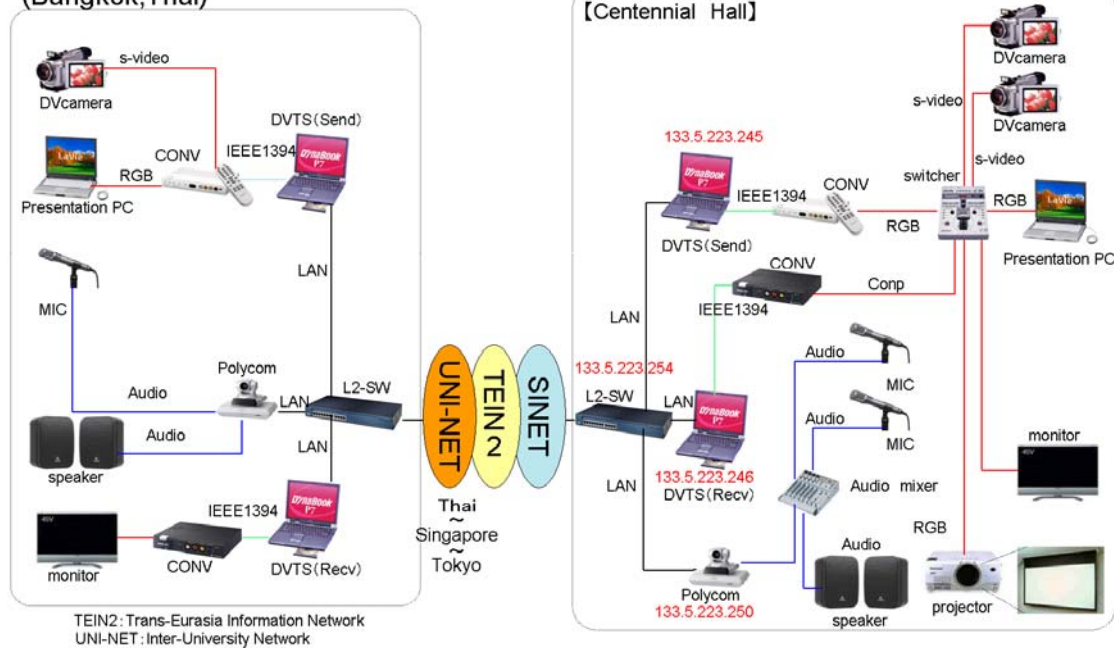

#77 ELSA2006 in Seoul: Live Demonstration 1 2006.10.19

#77 2006.10.19

Configuration of teleconference(demo1):10/19 13:30~17:00

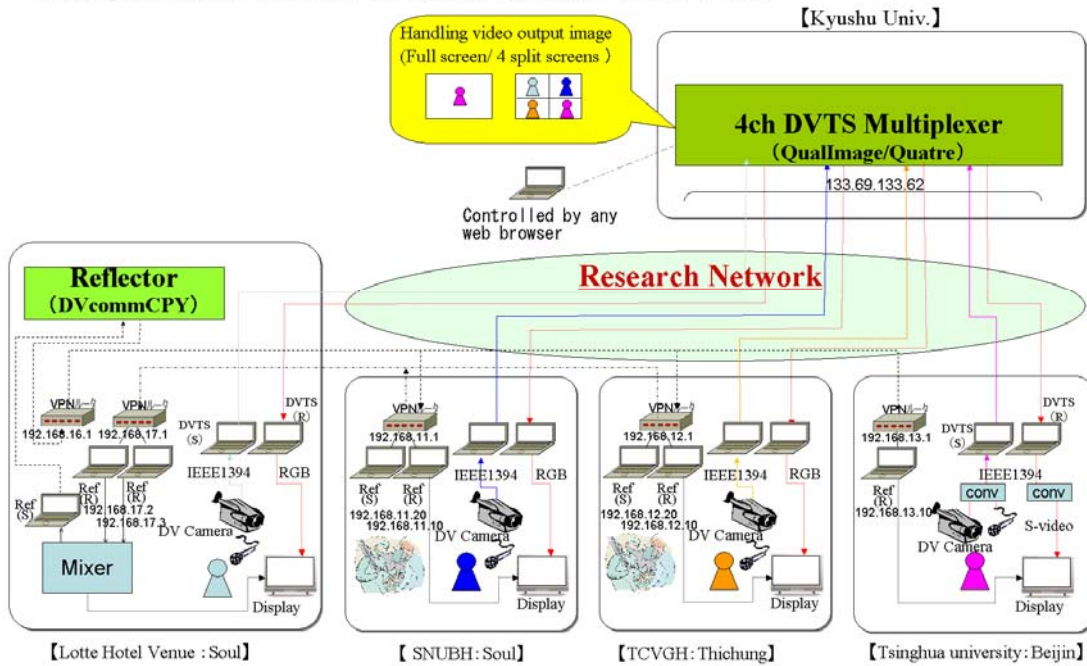

#78 ELSA2006 in Seoul: Live Demonstration 2 2006.10.20

#78 2006.10.20

Configuration of teleconference(demo2):10/20 13:30~17:00

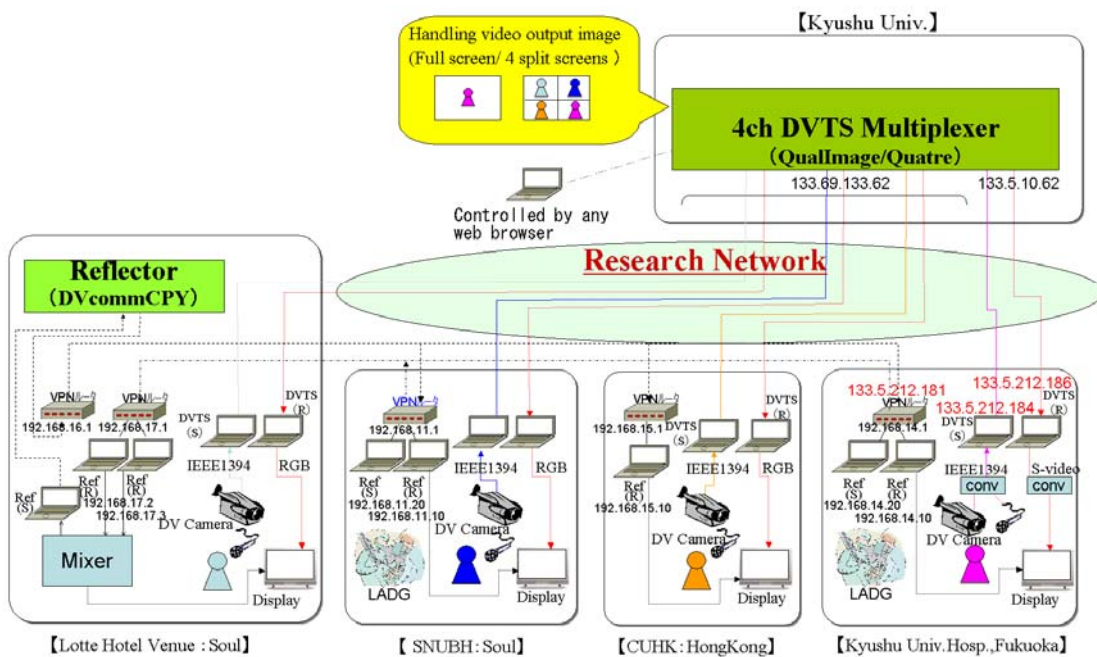

#79 Asian Month Public Program Seminar 2006.10.26

#79 2006.10.26

System Configuration of Teleconference (2006.10.26)

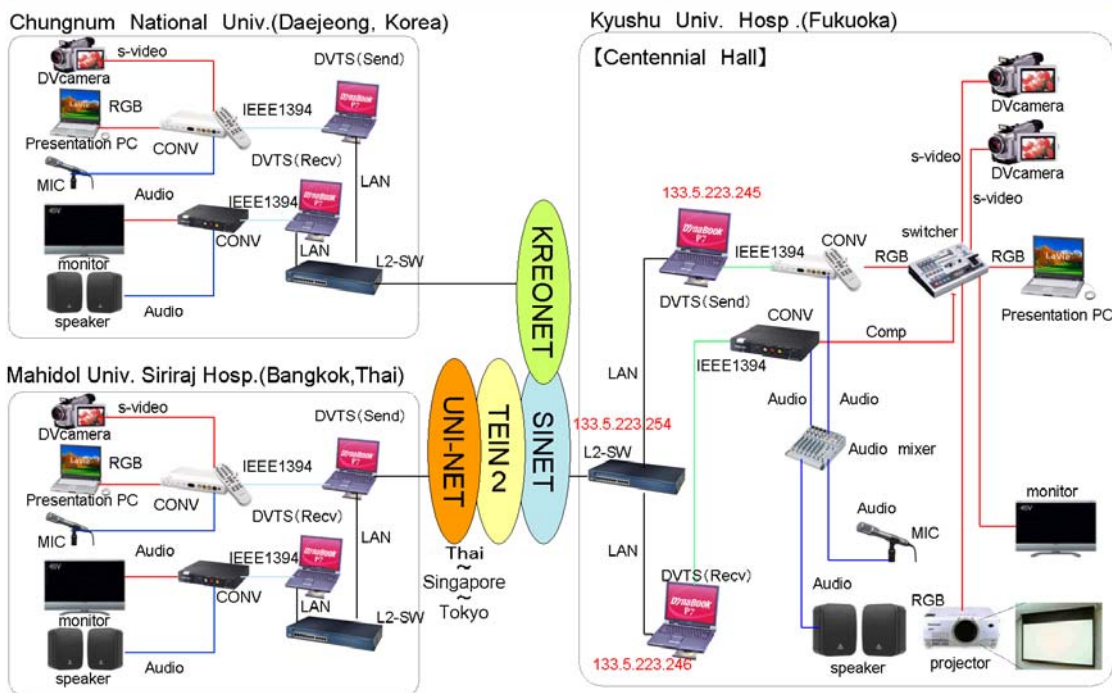

#80 The 26th Joint Conference on Medical Informatics 2006.11.2

#80 2006.11.2

Configuration of Live surgery

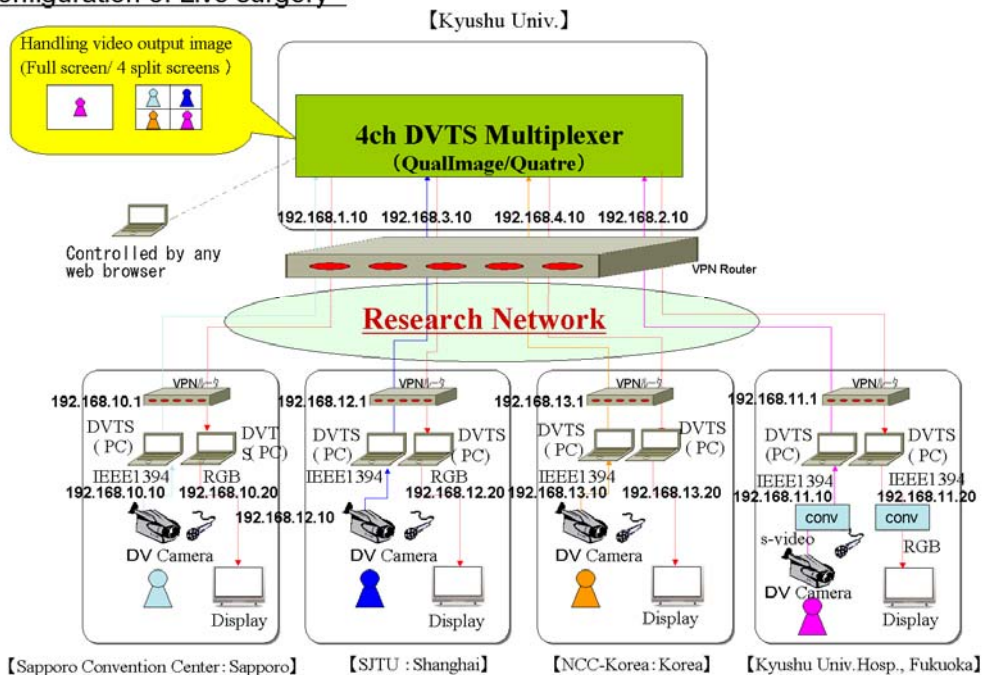

#81 The 1st Asia-Pacific Gastric Cancer Conference 2006.11.21

#81 2006.11.21

Configuration of Live surgery: 11/21

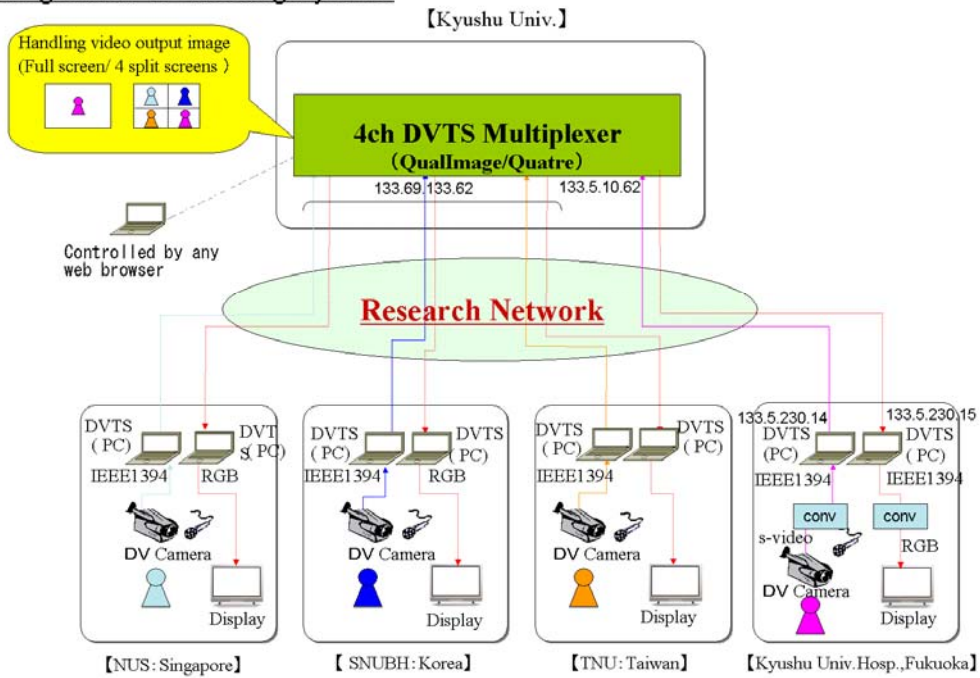

#82 The 1st Core University Program of Pharmacy 2006.12.22

#82 2006.12.22

System Configuration of Teleconference (2006.12.22)

Beijin Univ.(Beijin, China)

Kyushu Univ. Hosp.(Fukuoka)

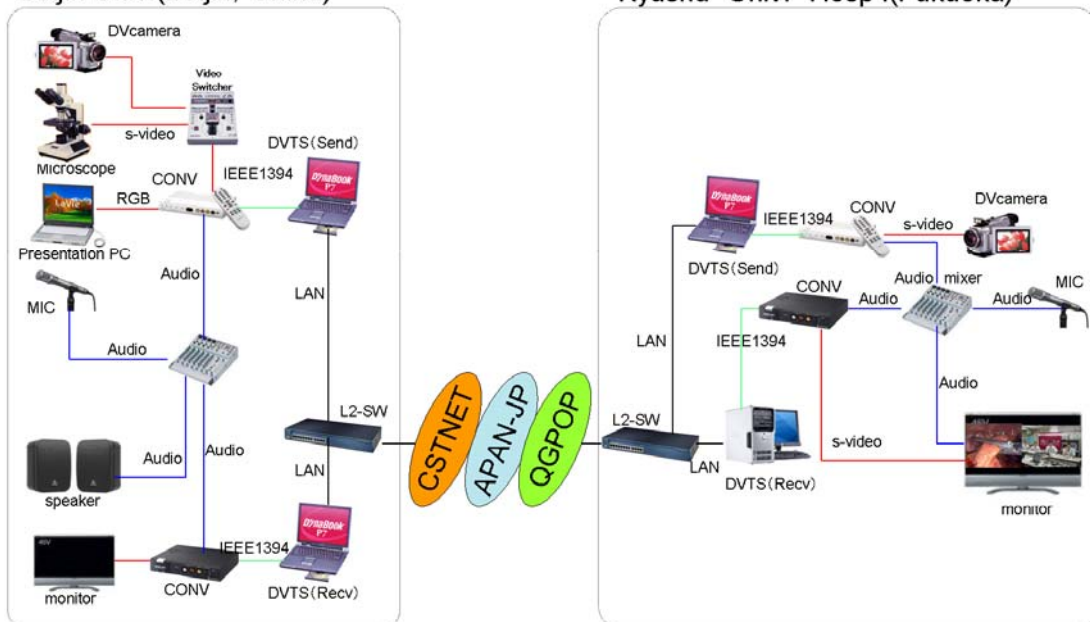

#83 The 23rd APAN Meeting - Workshop on bird influenza 2007.1.24

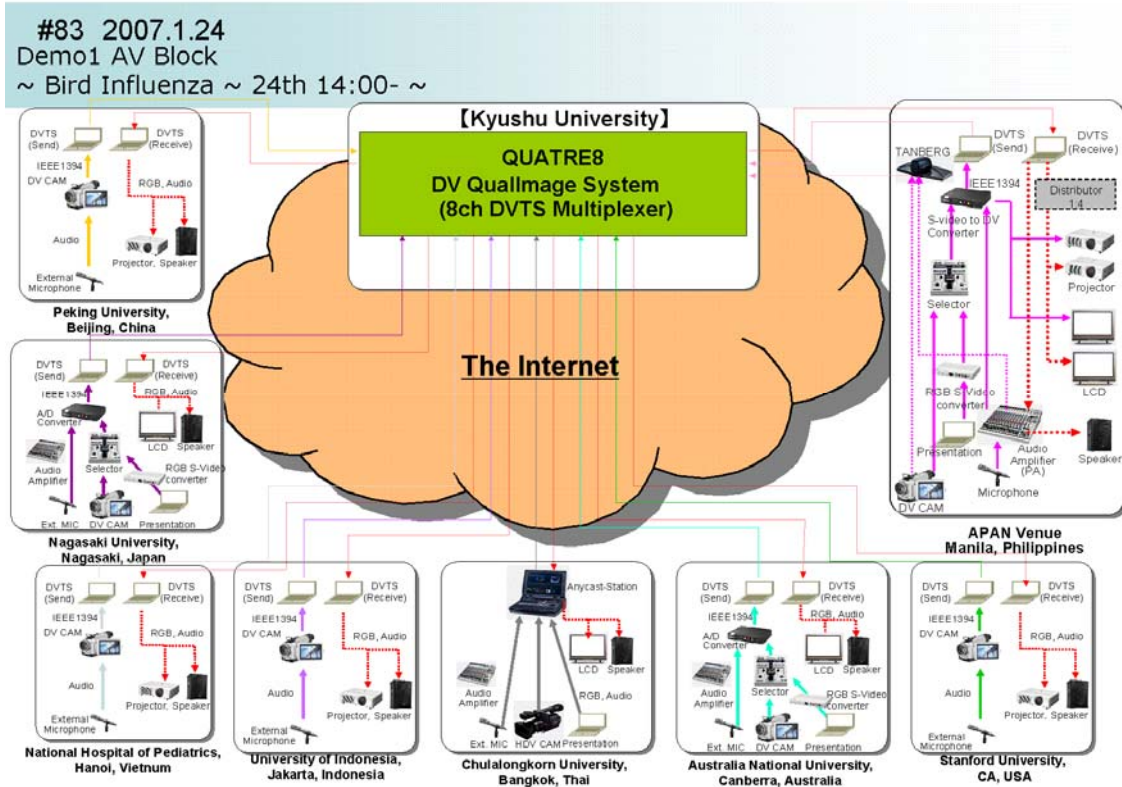

#84 The 23rd APAN Meeting - Live Demonstration I 2007.1.25

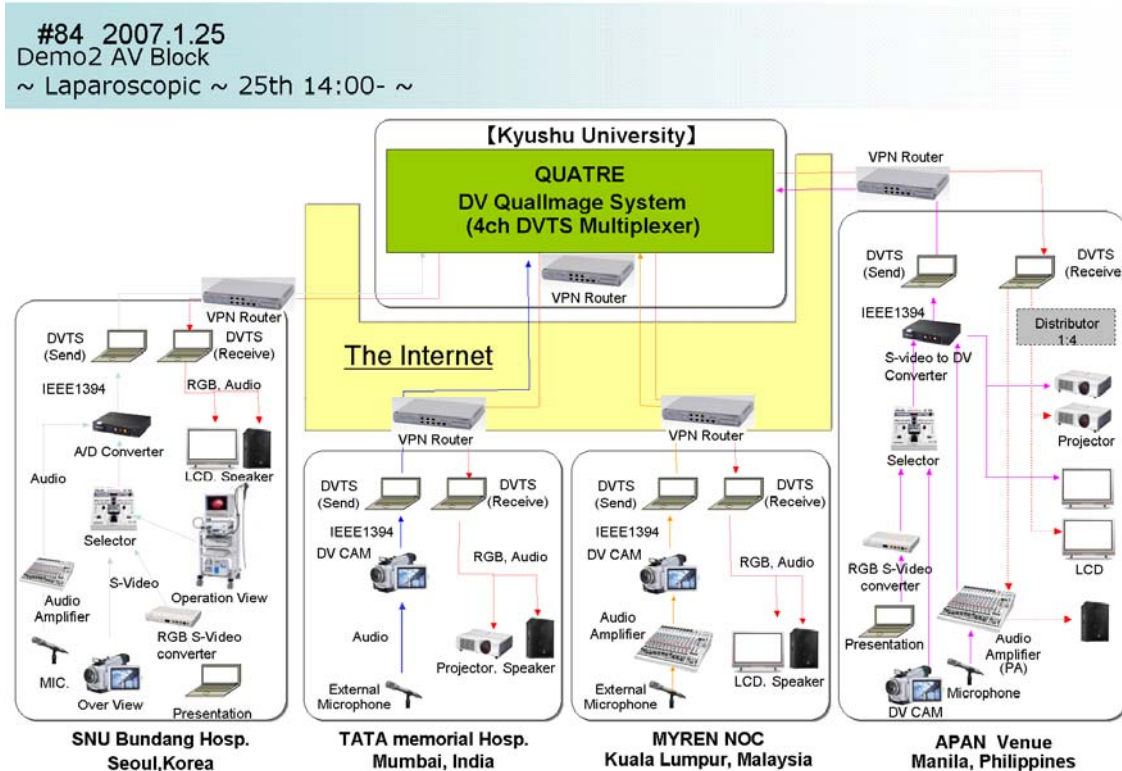

#85 The 23rd APAN Meeting - Live Demonstration II 2007.1.24

#85 2007.1.24
Demo3 AV Block
~ Training Centres ~ 25th 16:00- ~

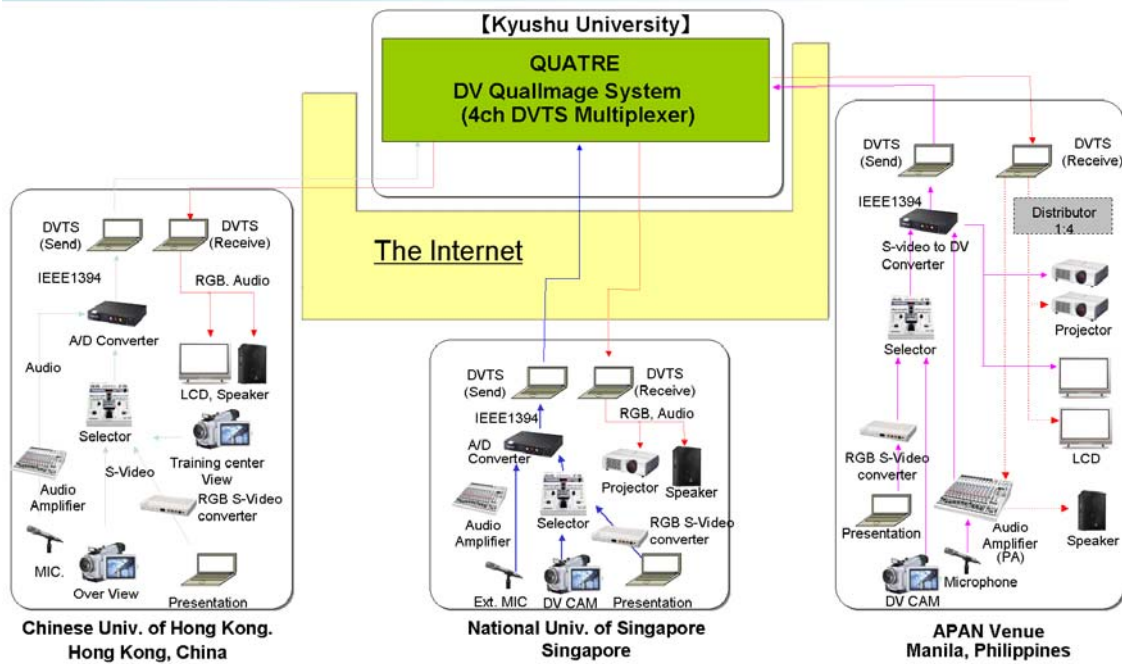

#86 China, Korea and Japan Joint Symposium 2007.2.1

#86 2007.2.1

Composition of Symposium and Demonstration_2007.02.01

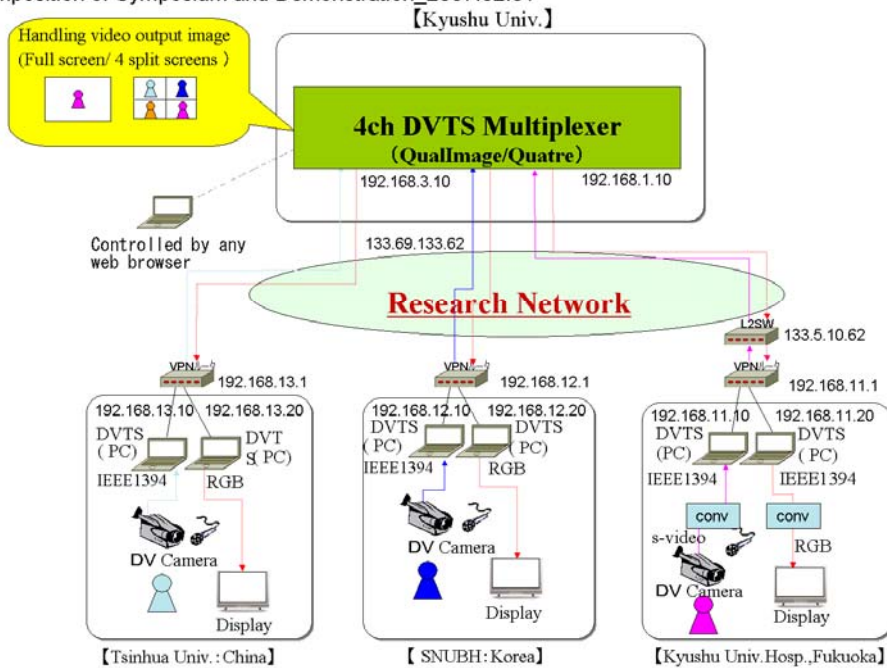

#87 Demonstration for KOSEF delegate 2007.3.5

#87 2007.3.5

System Configuration of Teleconference (2007.3.5)

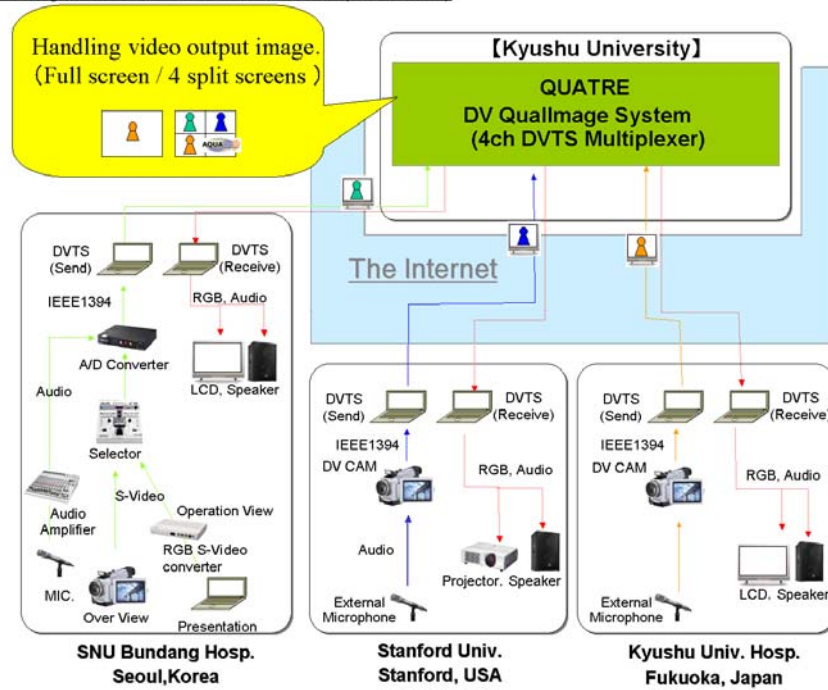

#88 Siriraj Hospital Endoscopic Seminar 2007.3.6

#88 2007.3.6

System Configuration of Teleconference(2007.3.6)

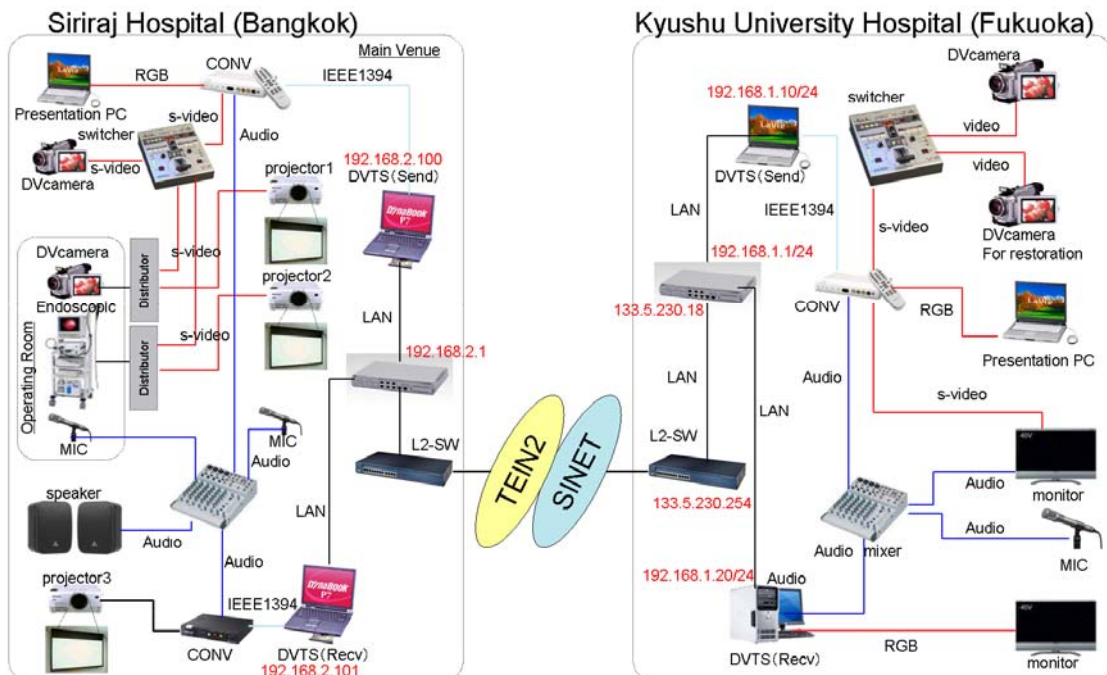

#89 NTU Endoscopic Seminar 2007.3.14

#89 2007.3.14

System Configuration of Teleconference(2007.3.14)

National Taiwan University (Taiwan)

Kyushu University Hospital (Fukuoka)

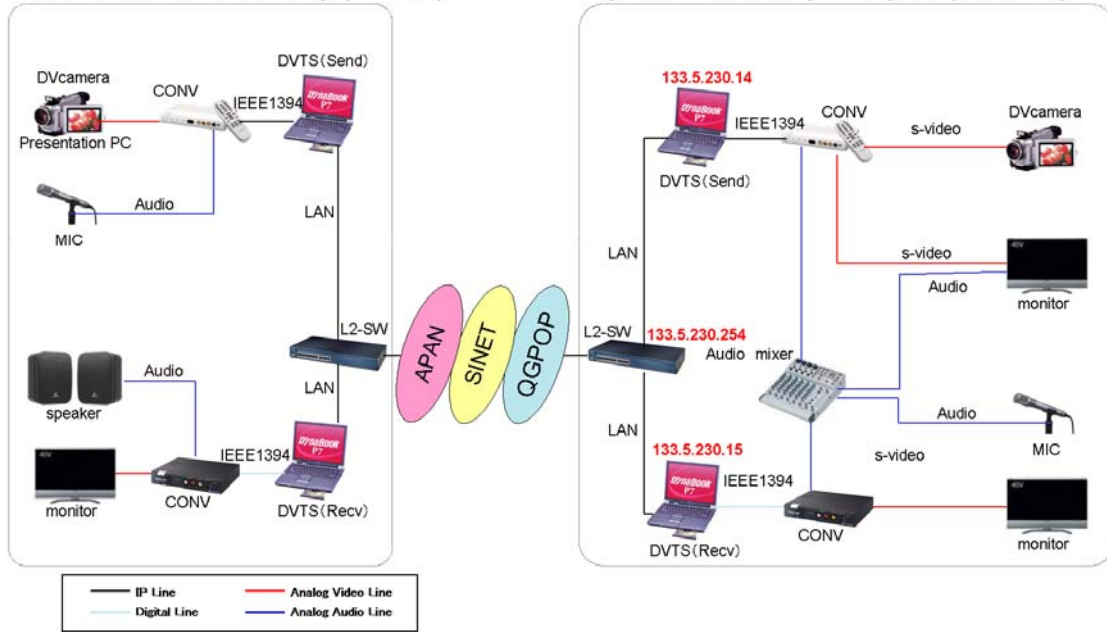

#90 Mini Symposium in SNUBH 2007.3.17

#90 2007.3.17

System Configuration of Teleconference(2007.3.17)

SNU Bundang Hosp.(Korea)

Kyushu University Hospital (Fukuoka)

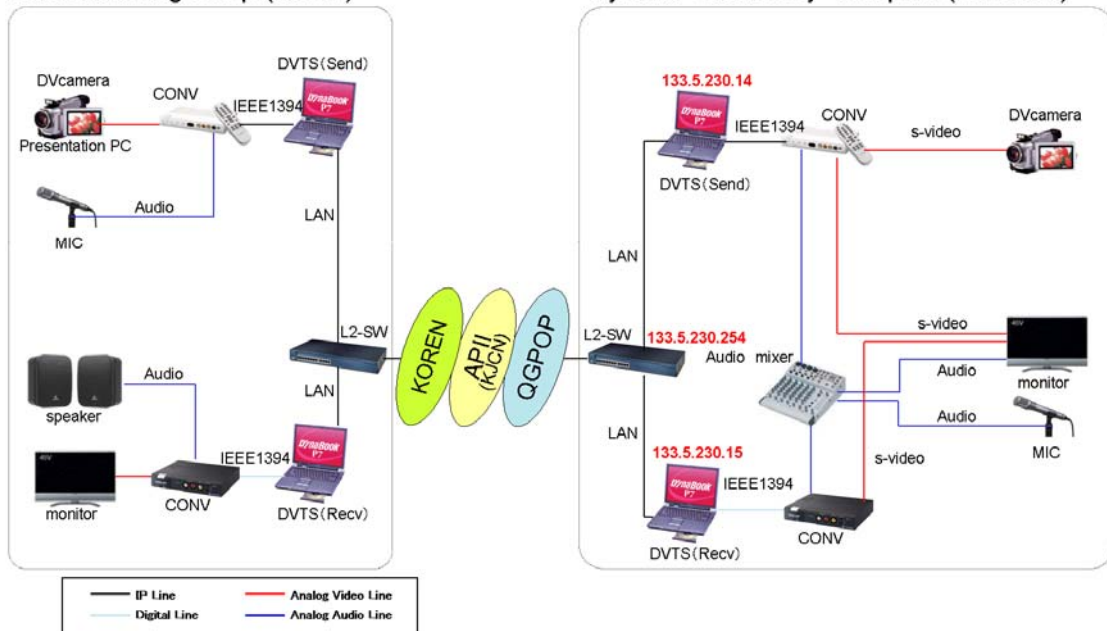

#91 APHPBA Teleconference 1 2007.3.22

#91 2007.3.22

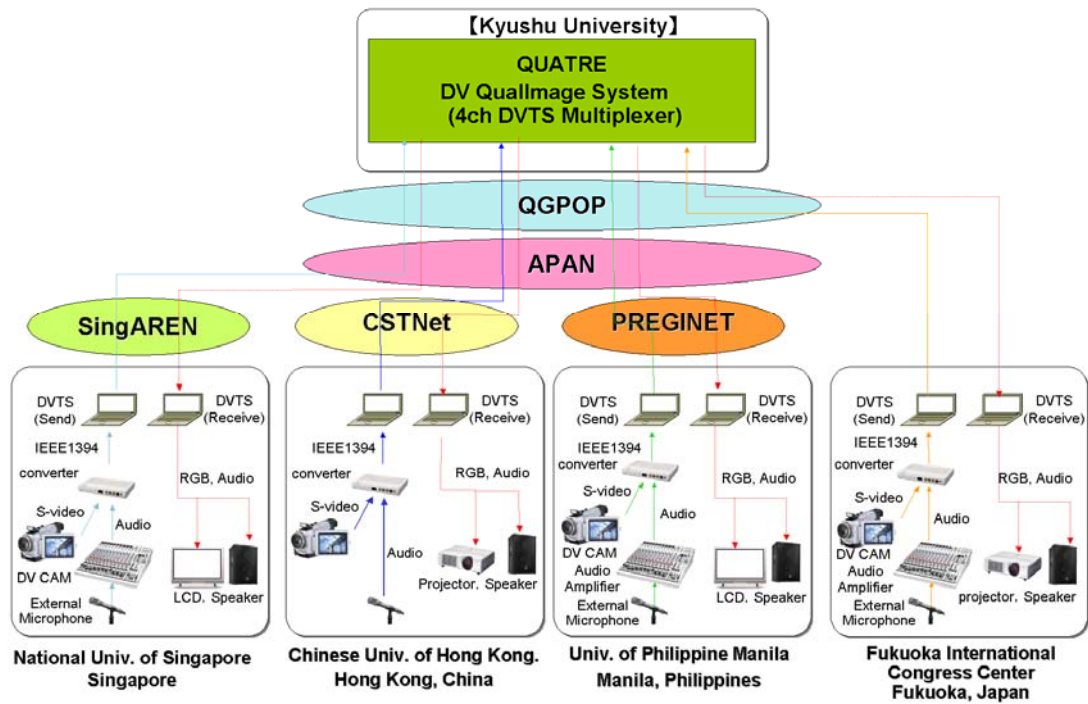

#92 APHPBA Live surgery demonstration with high-definition 2007.3.23

#92 2007.3.23

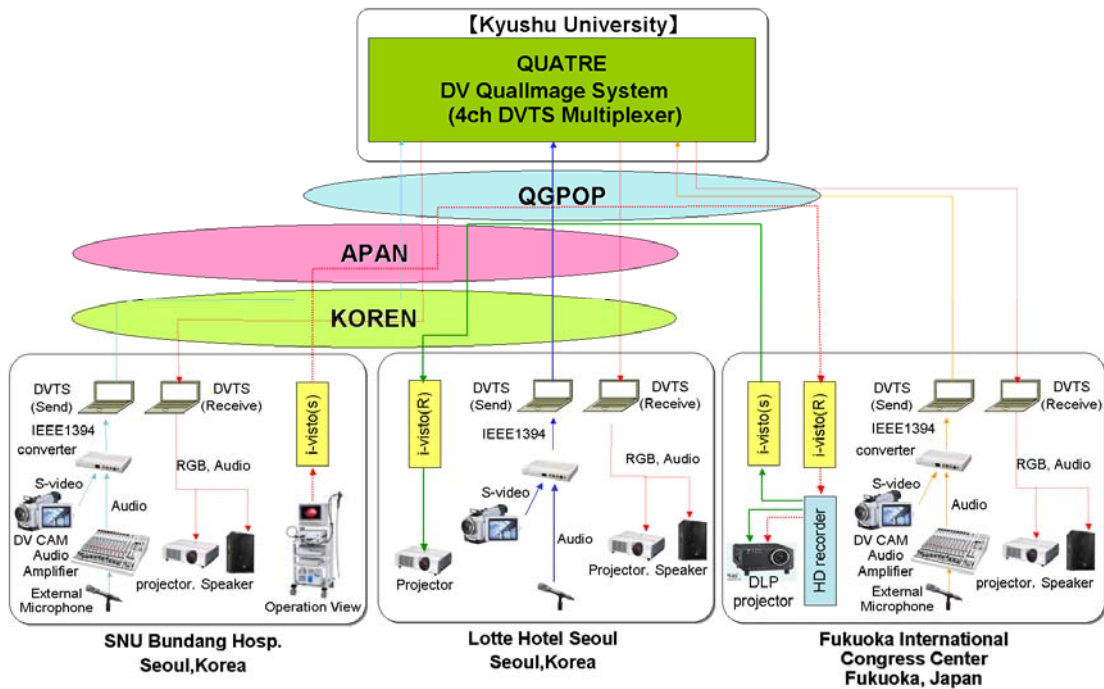

#93 APHPBA Teleconference 2 2007.3.23

#93 2007.3.23

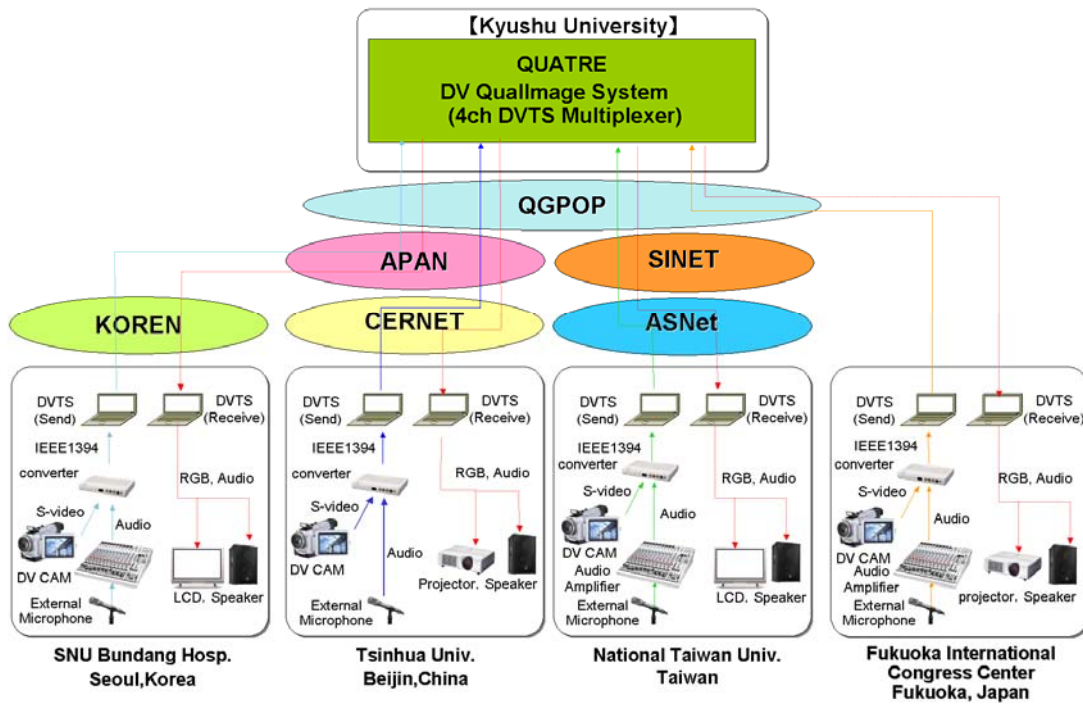

#95 Endoscopic teleconference 2007.3.28

#95 2007.3.28

System Configuration of Teleconference(2007.3.28)

Mahidol Univ. Siriraj Hosp.
 (Bangkok,Thai)

Kyushu University Hospital (Fukuoka)

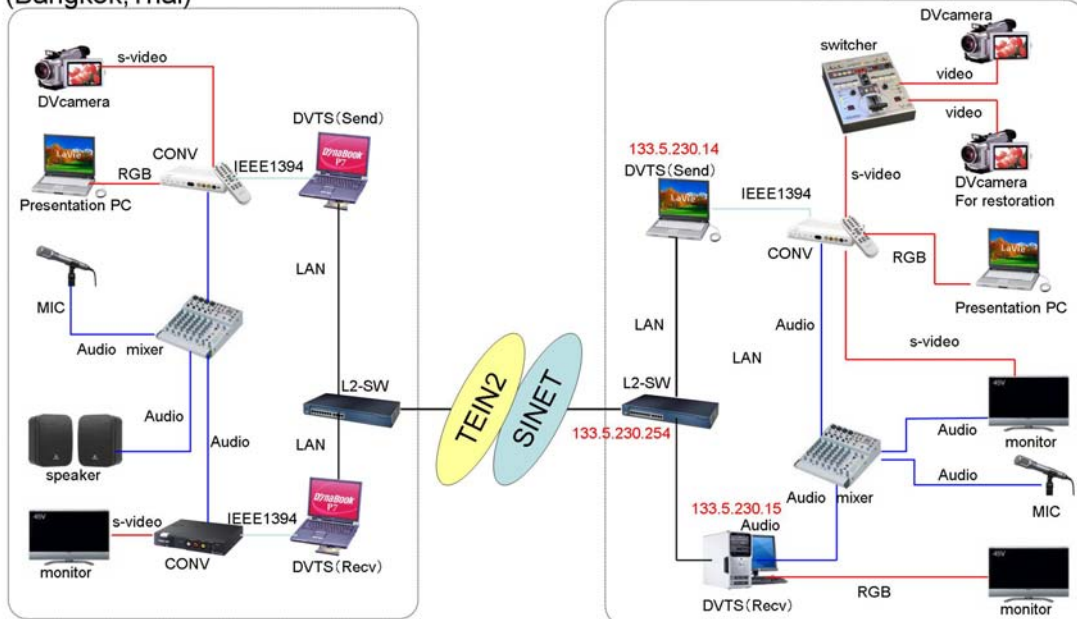

#96 Live demonstration of gastric surgery 2007.3.30

#96 2007.3.30

